



UNIT II

Photo: WI DNR



Chapter 7 Best Management Practices

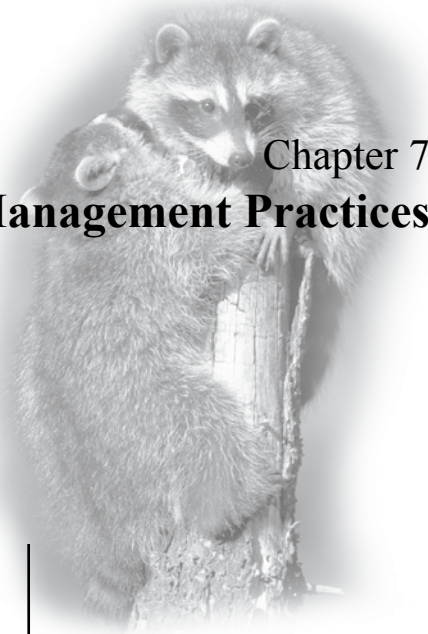

Objective - *Students understand Best Management Practices for Trapping are needed to address animal welfare, trapping, efficiency, selectivity, and safety in furbearer management programs.*

Introduction

In 1996, the Association of Fish and Wildlife Agencies (formerly known as the International Association of Fish and Wildlife Agencies) began a program to develop **Best Management Practices** for trapping as a way to improve the welfare of captured animals, and to document improvements in trapping technology. This project is one of the most ambitious in the history of the conservation movement. The WDNR and the WTA have been active in this program since inception, with experienced trappers involved from all regions of the state.

BMP's are necessary to sustain regulated trapping as a wildlife management tool, and to maintain the integrity of wildlife **conservation** programs throughout the United States.

Who Coordinates BMP's for Trapping

The Association of Fish and Wildlife Agencies coordinates the development of BMPs for trapping. **AFWA's** membership includes all 50 state fish & wildlife management agencies, federal agencies, and conservation organizations.

State furbearer biologists, veterinarians and trappers in addition to scientists from the University of Georgia and the University of Wyoming cooperated on the development of BMPs. Most funding for BMP research and development was provided through a Congressional appropriation to the U.S. Department of Agriculture.

BMPs are Based on Scientific Research

BMPs are based on the most extensive research effort of animal traps ever conducted in the United States. Traps tested were selected based on knowledge of commonly used traps, previous research, and input from expert trappers.

Trapping BMP's - Sustaining the Future of Trapping



All 50 state fish and wildlife agencies support the development of Best Management Practices.

Trappers, veterinarians and university researchers helped wildlife agencies evaluate more than 100 types of traps.

Wildlife veterinarians examined thousands of trapped furbearers for different types of injuries.

More than 250 teams of trappers and technicians participated in field testing.

Each state wildlife agency decides how to incorporate Best Management Practices into trapper education and furbearer management programs.

BMPs are valuable tools for biologists and trappers.

BMP-recommended traps resulted in no, little, or moderate injury to at least 70% of the animals trapped.

Traps that failed to capture and hold at least 60% of the species targeted did not qualify for recommendation.

To date, 32 state fish and wildlife agencies have been actively involved with the BMP program.

BMPs - Tools for Trappers and Wildlife Professionals

Trapping BMPs were developed to give wildlife professionals information they need to improve animal welfare. State fish and wildlife agencies use BMPs to continue the improvement of trapping systems throughout the United States.

Trapping BMPs include suggestions on practices, equipment, and techniques that will provide trappers and wildlife biologists with practical information to use in the field. These suggestions will improve animal welfare, help avoid the unintended capture of other animals, and increase public support for trapping.

BMP Evaluation Criteria

BMP traps were evaluated using criteria to measure the effects on animal welfare as well as trapping **efficiency**, selectivity, practicality, and safety.

Animal Welfare

Researchers tested live restraining traps for injuries to furbearers using two methods. One system evaluated specific injuries, and the other grouped the injuries into categories from mild to severe. BMP approved traps must have a low rate of injuries to the furbearing animals being studied. Recommended traps resulted in moderate, low, or no injury to at least 70 percent of the animals trapped.

Efficiency

Traps meeting BMP criteria must be able to capture and hold at least 60 percent of the furbearers that spring the trap.

Selectivity

Traps must be set and used in a fashion that limits the risk of capturing non-furbearing species while increasing the chances of capturing the desired furbearer.

Practicality

Each recommended live-restraining trap was evaluated by experienced trappers and wildlife biologists for practicality. Criteria used to measure practicality include cost, ease of use, ease of transport, storage, weight and size, reliability, versatility and the expected life-span of the trap.

Safety

Each recommended live-restraining trap was evaluated for safety to the user and other people who might come into contact with the trap.

Sources for BMP Information

All state fish and wildlife agencies have access to Trapping BMP publications as they are developed. Trappers can find all current information on Trapping BMPs at the following Web site:

- <http://www.fishwildlife.org> (search furbearer management)

The Furbearer Management website is maintained by the Association of Fish and Wildlife Agencies on behalf of state fish and wildlife agencies, trappers, and trapping organizations.

BMPs provide guidance to wildlife agencies and help responsible trappers make decisions in the field. Below are a few examples of the BMPs available.



Badger, is our only non-game furbearer in Wisconsin.

Traps and sets must be selective.

Experienced trappers evaluated cost, ease of use, trap weight, reliability, and other factors.

As new BMP information is published it is distributed by wildlife agencies, AFWA, and trapping associations in print and online



American marten is our only state endangered furbearer in Wisconsin.

Chapter 7 Review - Best Management Practices

Objective – Students understand Best Management Practices for Trapping are needed to address animal welfare, trapping efficiency, selectivity and safety in furbearer management programs.

State the name of the organization that coordinates development of Best Management Practices for Trapping.

1. State the full name of the organization known as AFWA.

Explain that BMPs are based upon scientific information and professional experience regarding currently available traps and trapping technology.

2. Experienced _____ were deeply involved with developing Best Management Practices for Trapping.
3. Using trapping BMPs can:
 - a. Improve _____ welfare.
 - b. Help avoid the unintended _____ of other animals.
 - c. Increase public _____ for trapping.

Identify where to find detailed BMP information for each furbearer species.

5. What is the URL address for the Best Management Practices website.



Chapter 8 Traps

Objective - Students demonstrate the ability to identify types of traps, prepare traps for use, and safely operate traps.

Introduction

Traps come in many different sizes, shapes and styles. Traps can be divided into two main groups: Live-restraining or kill-type traps.

Live-restraining Traps

Live-restraining traps are designed to capture an animal alive and unharmed. The most common live-restraining traps include foot-hold traps, cable restraints and **cape traps**. These traps allow release of non-target animals.

Kill-type Traps

Kill-type traps are designed to kill furbearers. The most common kill-type traps are the **body-grip trap** and cable snare. Wisconsin has strict regulations on the use of these traps which includes trap size and location where sets can be made. The use of kill-type traps is highly regulated to avoid incidental catch of non-target animals.

Some of the traps described in this chapter may not be legal in Wisconsin. Regulations vary from state to state, and from year to year within states. Know the regulations for Wisconsin, and follow them.

Live-restraining Traps

Foot-hold traps

Foot-hold trap means a trap, constructed of metal, designed to catch an animal by the foot. The most common types of foot-hold traps include longspring and coilspring traps. Foot-hold traps come in various sizes and strengths, each of which is appropriate for one or more specific species of furbearers.

Advantages of foot-hold traps include versatility, small size, and the ability to release animals. Foot-hold traps, along with cable restraints, are the most reliable traps for coyote, red fox, and gray fox.

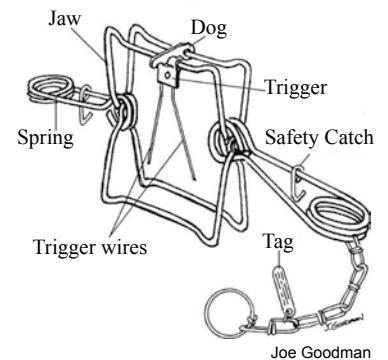
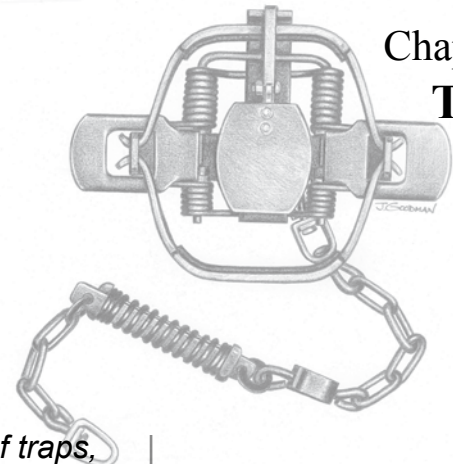

Kill-type body-grip trap.

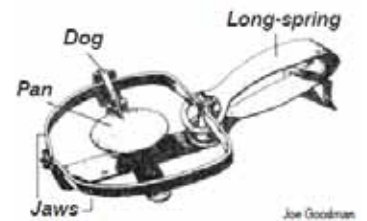

Live-restraining single longspring with plain jaws.



Live-restraining double longspring double-jaw foot-hold trap.

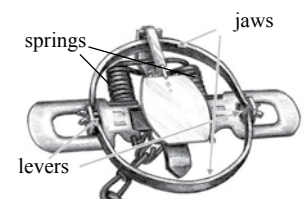

Live-restraining coilspring trap.



Modified coilspring trap.

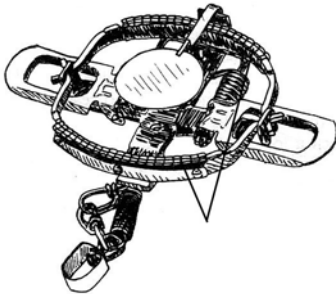

Joe Goodman
Coilspring Padded Foot-hold Trap

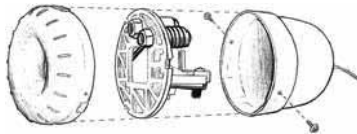

EGG™ Trap



Cable Restraint

- **Longspring Trap** - Longspring traps are the oldest type of foot-hold traps. Single longspring traps are best suited for small animals like mink and muskrat. Longspring traps are heavier than coilsprings. Double longsprings are a better choice for water sets made for large animals such as beaver.
- **Guarded Foot-hold Trap** - Guarded foot-hold—or stop-loss—traps, are used where kill-type traps are not suitable for capturing muskrats in shallow water. The spring-loaded guard restricts an animal’s movement, making it less likely they will twist free or injure themselves.
- **Coilspring Trap** - Coilsprings are the fastest kind of foot-hold trap. They work well in land sets for fox and coyote because of the coilspring’s speed, strength, and compact size.
- **Underspring Trap** - The underspring, or “jump” trap, was used by many trappers years ago. The jump trap is a little harder to set but is a bit faster and lighter than longspring traps. This trap type has not been manufactured for many years, but you may still find them hanging in old sheds, barns or at rummage sales.
- **Enclosed Trigger Trap** - Enclosed trigger traps are designed to catch raccoons and opossums. Traps like EGG™, Duffer’s™, Duke Dog-proof™ and Lil’ Griz™ traps incorporate designs to eliminate non-target catches because raccoons or opossums must reach through a small opening to trigger the trap.

Modifications are made to the jaws of basic traps in concern for the welfare of the targeted furbearer. The purpose of foot-hold trap modifications is to reduce injury to the captured animal’s foot. Several BMP traps are identified by jaw frame characteristics and modifications including those outlined below.

- **Padded foot-hold traps** have rubber pads on the jaws. The rubber acts as padding and cushions the animal’s foot. Rubber also prevents the animal’s foot from moving back and forth between the jaws.
- **Offset foot-hold traps** have jaws that are offset. The offset creates a space between the gripping surfaces when the jaws are closed. The offset ranges from 1/8 to 1/4 inch.
- **Double jaw foot-hold traps** use two metal frames on the jaws instead of one. One set of jaws is smaller, and these are inside of the regular jaws. The additional frame covers the area surrounding the animal’s foot, preventing any self-inflicted injury.
- **Laminated foot-hold traps** are another option that can increase efficiency and reduce injuries. Lamination, or additional metal, expands jaw thickness and increases the amount of surface area holding the animal’s foot. Lamination normally is added by welding an additional strip of metal to the top or bottom of the jaw that sits perfectly flush with the original jaw. Some trappers also use double lamination, welding one strip above, and one below the jaw.

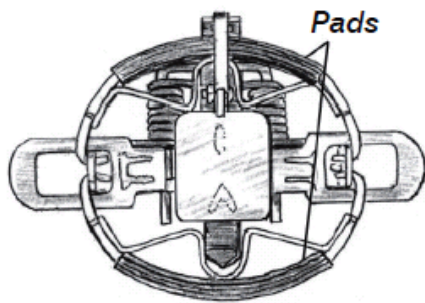

Padded Jaws

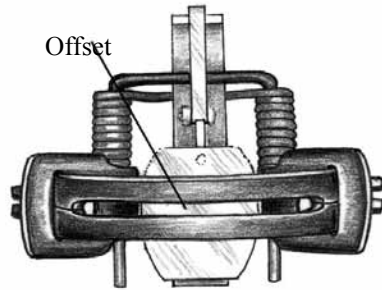

Offset Jaws

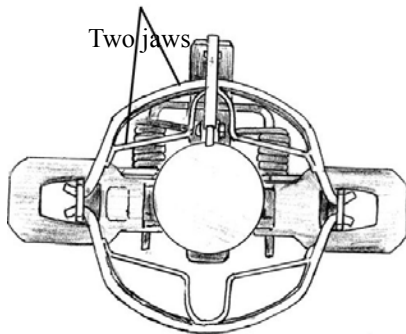

Double Jaws

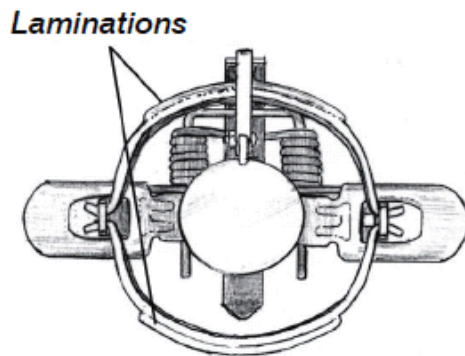

Laminated Jaws

Cable Restraint

The cable restraint is a device consisting of a cable, a relaxing lock, and a swivel used to live-capture fox, coyote, and bobcat. Cable restraints function by holding an animal by the neck or body. To be legal in Wisconsin, the device **must** consist of a reverse-bend washer lock that can move in both directions on the cable. The cable restraint **must** also include a breakaway device rated at 285 pounds or less to allow non-target animals to free themselves. To avoid entanglement, the cable restraint must be set in an area away from thick brush, saplings or fences. The cable restraint is lightweight and requires less tools to set, making them a tool of choice for many canine trappers. Chapter 13 covers cable restraints in greater detail.

Cage Traps

The **cage trap** functions by enclosing the animal completely inside a cage or box. A treadle (or pan) works as the trigger, and when stepped on, causes the open door to close behind the animal. Cage traps come in various sized models and work well in areas where the chance of domestic and non-target capture is likely. Non-targets can be easily released. The disadvantage to the cage trap is its cost and difficulty to use and conceal because of its size.

In many cases, carefully covering the cage trap with natural camouflage (bark, branches, leaves) will make it more effective. In metropolitan areas, the cage



Ed Dubuque

Gray fox in foot-hold trap

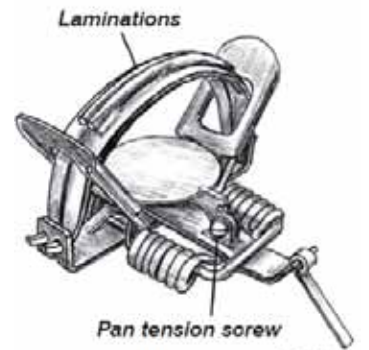

Joe Goodman

Laminated trap jaws.

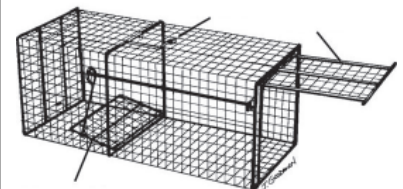

Live-restraining cage trap



Kill-type colony trap

Note: In Wisconsin, special regulations require medium and large body grip traps to be used with special care. Check the current trapping regulations to be aware of these requirements.

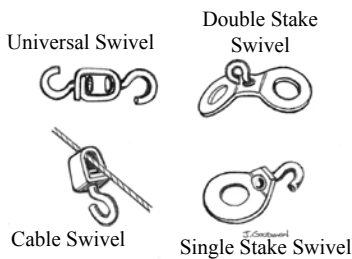

Universal and stake swivels.



Three pronged grapple.

trap might be the only legal means of capturing furbearers. Many nuisance trappers use cage traps to relocate smaller animals such as woodchucks, squirrels and rabbits. Raccoon, skunk, opossum, fisher and weasels can be caught in cage traps.

Kill-type Traps

The most common kill-type traps include the **body-grip trap** and cable snare. Other kill traps include the **colony trap** and submersion sets.

Body-grip Traps

A body-grip trap is designed to catch the animal around the neck or chest area. When the trap is properly set, the animal is killed quickly by a combination of striking and clamping forces. In most cases, the animal is struck at the base of the skull resulting in unconsciousness and quick death. Careful attention must be paid to trigger placement and how the animal will approach the set to make the trap most effective.

Body-grip traps are popular with water and land trappers. It is very important that you read the Wisconsin trapping regulations for specific rules on the use of body-grip traps.

Cable Snare

A cable snare is a device similar to the cable restraint, but is designed to kill the animal. In Wisconsin, cable snares are used to trap beaver and otter and must be at least 50% underwater to be legal. **A cable snare is NOT a cable restraint.** A cable snare consists of a non-spring activated, galvanized aircraft cable which includes a non-relaxing mechanical lock and swivel. The non-relaxing mechanical lock on the cable can only move in one direction. When the animal pulls, the cable gets tighter leading to suffocation and death. Cable snares are not legal on dryland. Cable snares should be used in conjunction with a submersion system to insure quick death.

Colony Trap

A **colony trap** is a type of cage trap with one or more one-way entrances designed to be used as a submersion set for muskrat and mink. It is called a colony trap because you can catch multiple muskrats at one time. Check regulations for size specifications, rules and trapping seasons before using a colony trap in Wisconsin.

Submersion Sets

Foot-hold traps are generally classified as “live-restraining” traps. However, foot-hold traps can be used in a modified set to facilitate death through submersion. To make a submersion set, use a length of galvanized cable (3/32” or

1/8") with a one-way sliding lock. One end of the cable is staked near shore where the trap is set. The other end of the cable is staked or anchored in deep water (minimum 24" for muskrats and 42" for beaver). The one-way sliding lock allows the animal to swim toward deeper water, but not back to shore. This trapping system is covered further in Chapter 11.

Trap Anchoring Systems

Traps must be attached to something to hold an animal. Normally a chain is attached to a trap. Trappers can use several methods to secure the chain including single stakes, cross stakes, earth anchors, drags, or grapples.

- **Stakes** are normally made of metal (rerod) and are used to secure the chain to the ground. A stake needs to be long enough to hold the largest animal that might be caught. Under most conditions stakes should be 18-24 inches in length. Even longer stakes are needed in sandy soils.
- **Cross Staking or Double Staking** is a method used for stronger animals like bobcat, fox and coyote. Adding a second stake prevents larger animals from "pumping" a single stake out of the ground. If the stakes do not hold well, you must find a new place to make your set. You must not let an animal escape with a trap on its foot because it will cause injury.
- **Earth Anchors or Disposable Stakes** are attached to a cable which is driven into the ground with a tool. After being pounded into the ground, the cable is given a tug and the anchor turns sideways, securing it in place. Earth anchors are very strong, and need to be dug out of the ground when you remove the set.
- **Drags** are also a type of anchoring system for traps. Drags are commonly used for sets made in the open. Drags allow an animal to move a short distance and reach cover.
- **Grapples** are metal devices secured to the chain of traps. Grapples work like drags, but they are not as heavy. The shape of the metal grapple causes it to dig into the ground or vegetation, restricting the furbearer's movement. Once in cover it usually becomes entangled in heavier, dense brush. When approaching the trap set you can usually follow the tracks of the grapple in the ground.

The Importance of Using Swivels

A variety of good swivels are needed for quality sets that catch and hold certain furbearers. Swivels reduce the chance of injury by allowing a trap to move freely in the same direction as the animal's foot. It's recommended that all dryland foot-hold traps have at least 3 swivels including a base swivel on coilspring traps.

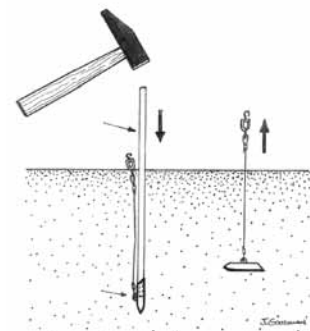

Earth Anchor.

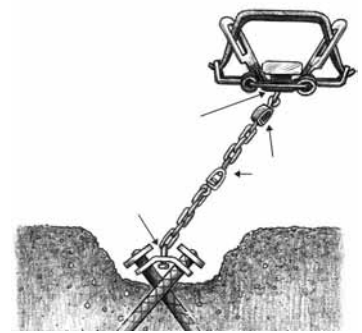

Cross-staking.



In-line shock spring.

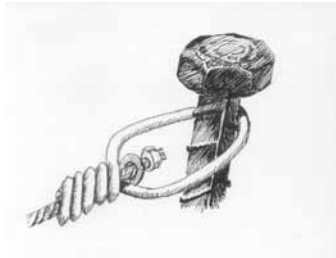

Natalene Cummings

Cable device and swivel at stake.

Trap Tuning

- Weak springs should be replaced.
- Level pan and adjust tension.
- Swivels and hooks must be strong and operate freely without binding.
- Use a metal file to smooth down any sharp or rough edges on the jaws.
- Check chains for worn links.
- Make certain your traps are tagged to comply with state regulations.

Lap-link swivels, stake swivels, and universal swivels can be used to fasten a chain to a stake. When two stakes are needed trappers use a special cross-staking swivel.

Universal swivels can be used in the middle of chains. Four-way swivel, or box swivel, is another name for a universal swivel. A universal swivel is also used to attach the chain to a trap at the center of the base-plate.

J-hooks are used on some swivels. A special s-hook tool can be used to close and open the hook without damaging it. Some coyote trappers weld the connection to keep it from pulling open.

Swivels of various types, including universal swivels, are also used in combination with sliding locks in submersion sets.

Always use the highest quality swivels in your trap systems to prevent an animal from escaping or being injured. The proper use of swivels is an important part of responsible trapping.

Another way to reduce injury is to include shock springs. Shock springs should be used in combination with swivels, chains, stakes, drags, and grapples. One or two shock springs can be inserted in the chain and are used to help hold the animal and reduce leg and shoulder injury.

Trap Tuning

Inspection and Adjustments

Whether new or used, all traps require some minor adjustments to operate efficiently. When you make these adjustments it is called “trap tuning.” It is very important that you inspect and tune all of your traps before the start of each season. Check for bent or broken parts, weak springs and damaged or broken chains. Parts are available for most traps or you can just save the broken traps as parts for future traps needing repairs. File down any sharp edges or burrs especially on the inside edges of the jaws and make sure trap tags are attached to all traps.

Foot-hold Trap Adjustments

When adjusting foot-hold traps, the trap pan needs to be level with the jaws. If the pan rests too high or too low, the frame will need to be bent in or out below the “dog.” Bend it out to raise the pan. Bend it in to lower the pan.

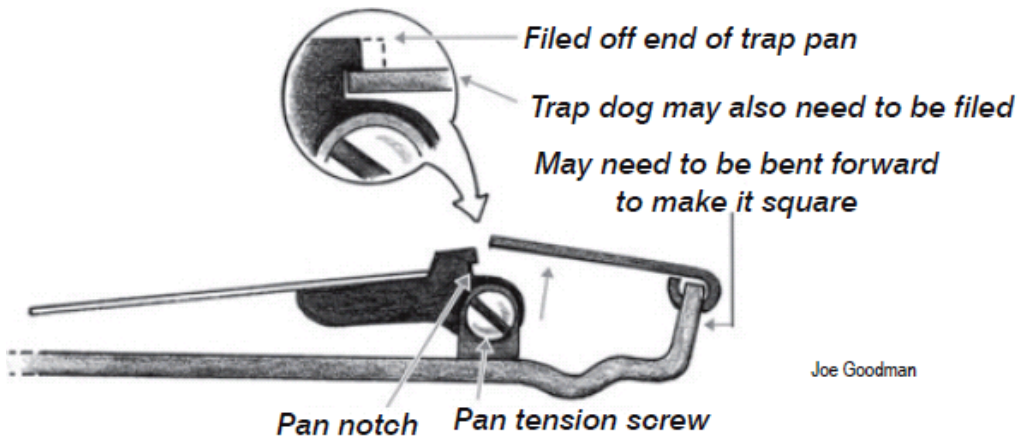

Pan tension is another tuning adjustment. It is measured by the amount of weight it takes on the trap pan to fire the trap. Most new traps have pan tension adjustment screws. When trapping larger animals, increase the tension so that smaller species will not trigger the trap. For example, two pounds of pan tension is a good setting for fox. You can purchase a commercial testing device to measure pan tension. You can also use a tennis ball can, liquid soap container, or PVC pipe filled with the weight of sand that matches your desired tension.

Pan throw is another adjustment. Pan throw is the distance the pan must be depressed to fire the trap. Use a shorter pan throw when tuning a trap for high pan tension. To adjust the pan throw, you file some metal off the end of the notch where the dog fits. This notch determines how far the pan must drop before the trap will fire. Use a file to make certain the end of the dog and the notch in the trap pan are squared off. If the dog or the notch are rounded, your trap may release too easily.



Plastic tube-like containers can be filled with sand or lead weights to create a certain known weight. Use this to test for the appropriate pan tension.

Increase pan tension by tuning the pan tension screw to the right, or clockwise. Turn the pan tension screw to the left to decrease pan tension.

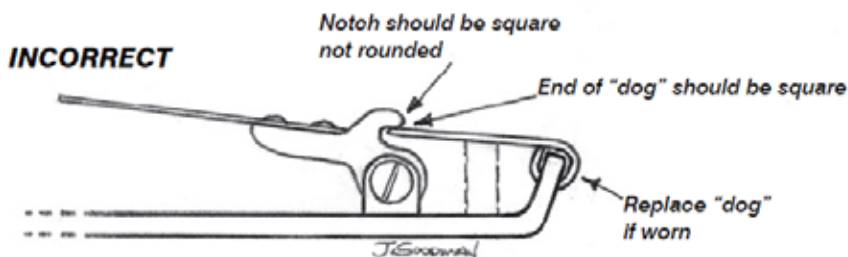
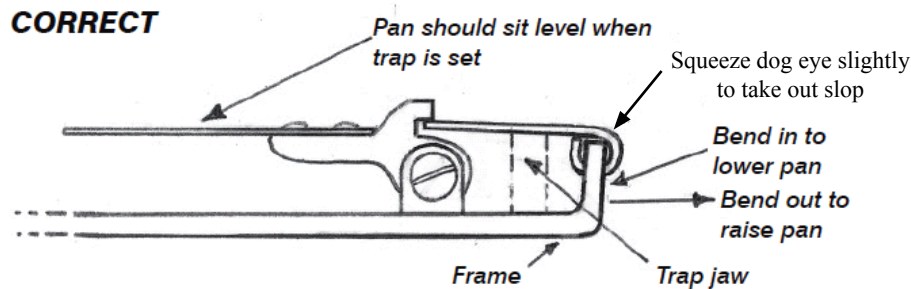

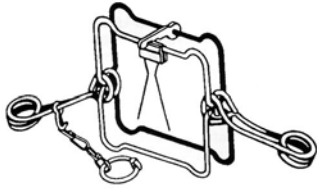

Joe Goodman

Body-grip traps should be set to close from top to bottom to work properly

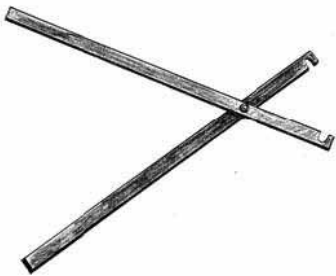

Body-grip trap setting tongs.



Body-grip trap safety gripper.

Measuring Jaw Spread on Foot-holds

There is no standardized way of determining a trap's measurements using manufacturer designations such as "No. 2" coilspring. To find traps that meet jaw spread measurements for BMPs or Wisconsin's regulations you may need to check jaw spread in two places: at the jaw, and at the hinge posts.

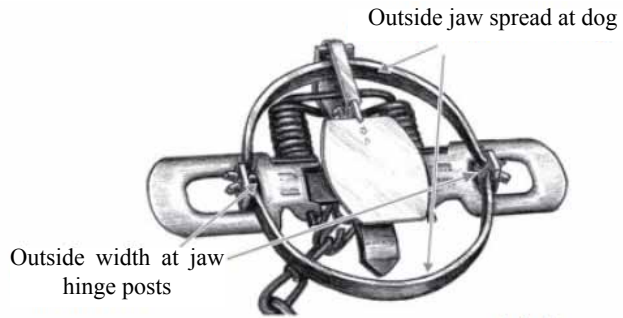

Joe Goodman

You can take these two measurements by setting the trap. Carefully measure the **outside** spread of the jaw frame at its widest point along the line from the dog to the opposite side. Then measure the width between the outside edge of the two jaws where they connect to the hinge posts. You may find slight differences in jaw spread measurements on the same make and model of traps.

Body-grip Trap Adjustments

Body-grip traps may require trigger adjustment. If there is too much play in the trigger your trap may misfire, or strike the animal in a poor location. If there is a gap in the top of the trigger assembly you can crimp it with a pair of pliers or a vise until the ends are flush.

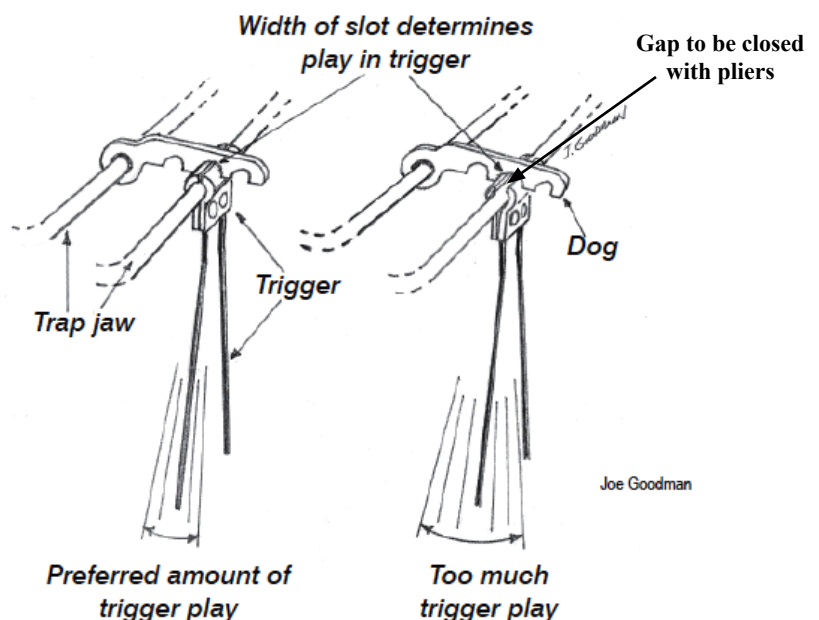

Joe Goodman

When adjusting traps it is also a good idea to attach the staking equipment you will be using to your trap chain. This equipment can be dyed with the trap and then there will be less handling of the trap once it has been dyed and waxed.

Measuring Maximum Jaw Spread on Body-grip Traps

When it comes to body-grip trap regulations, vertical and horizontal measurements are two important variables. Regulations in regard to body-grip trap size are in place to reduce the chance of catching non-target or domestic animals.

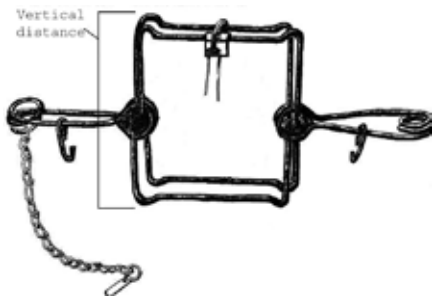

To determine the **vertical height** of a body-grip trap, measure from the widest points on the outside of the jaws

****NOTE:** Measurements must be taken when the trap is SET.

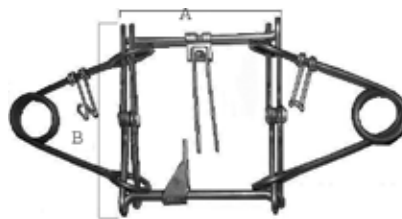

To determine the **total square inches** of a body-grip trap, measure from the widest points on the outside of the jaws

****NOTE:** Measurements must be taken when the trap is UN-SET.

Trigger Adjustments on Body-grip Traps

Experienced trappers adjust the shape of triggers on body grip traps to make them selective for certain species of furbearers. Triggers can be shaped to allow “streamlined” otter to swim through large body-grip traps and still catch beaver, which have bigger bodies. These are just a few examples of the ways you can make your sets selective and avoid nontarget catches. To learn more study BMP documents for the species you trap.

Trigger Configurations

Note: Trappers often set body-grip traps with triggers on the bottom to reduce pelt damage to the upper part of the pelt.

- Small - for mink
- Small - for muskrat
- Medium - for raccoon and fisher
- Large - beaver and otter



Trapper Education student using setting tongs.

Trap	Common Dimensions
110 Body-grip (one spring)	4.5" by 4.5"
120 Body-grip (two springs)	4.5" by 4.5"
150 Body-grip (one spring)	5" by 5"
160 Body-grip (two springs)	6" by 6"
220 Body-grip	7" by 7"
280 Body-grip	8" by 8"
330 Body-grip	10" by 10"

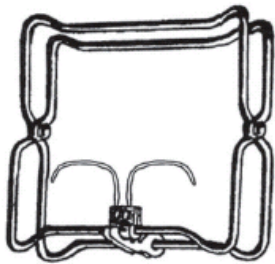

Small - mink

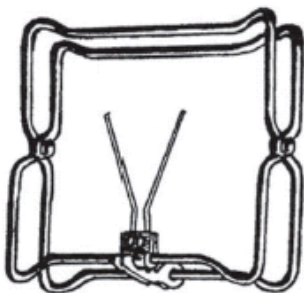

Small - muskrat

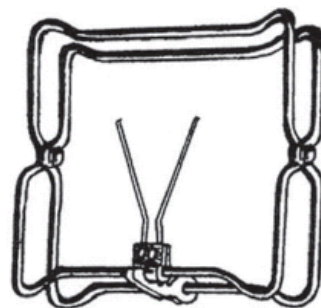

Medium - raccoon and fisher

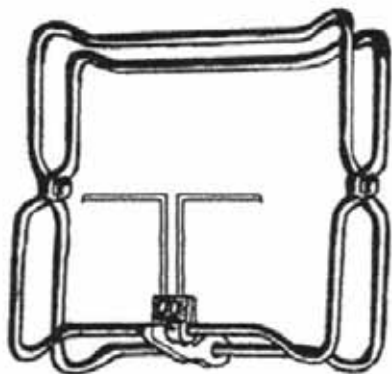

Large - beaver and otter

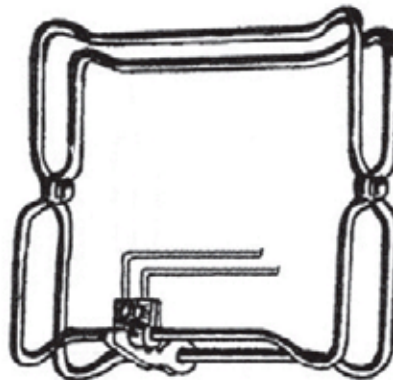

Large - beaver, not otter

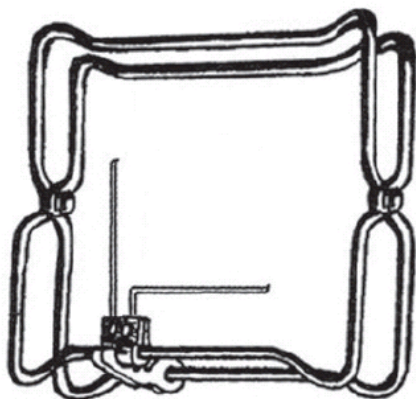

Large - beaver, not otter

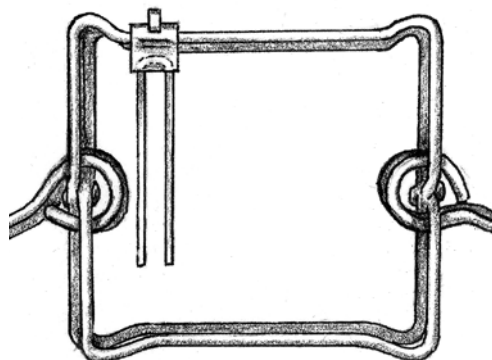
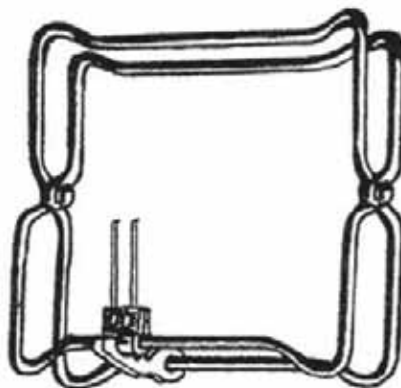

Large - beaver, not otter

Trigger Configuration Illustrations by Joe Goodman

Trap Preparation

All equipment that is used in land trapping should be clean and free of foreign odors. New traps are shipped with a light coat of oil that needs to be removed before being used. Before preparing traps, put a nail or small piece of trapping wire between the jaws of each trap to hold them slightly open. This allows the traps to be cleaned, dyed and waxed evenly and in between the jaws as well. It will also keep the jaws from sticking shut once the trap is waxed.

There are many methods to cleaning traps. Some methods include:

- 1) Put the traps in a large wash tub and fill it with water and powdered automatic dishwasher detergent. Boil the traps in the soapy water for 30 minutes then remove and rinse them clean.
- 2) Wash traps with a mild, odorless detergent.
- 3) Soak traps overnight in a saltwater and vinegar solution.
- 4) Boil the traps in clean water and pour or skim the grease off the top of the water.

Hang the traps outside until a light coating of rust forms. This may take several weeks. The rust will help the dye bond to the metal without hurting your traps. New traps will take dye better if they have a light coat of rust formed on them. Excess rust on used traps is damaging to traps and should be removed with a steel brush or buffing wheel.

Dyeing

When your traps are lightly rusted they are ready to dye. Dyeing of traps slows rusting of traps, makes them easier to conceal and removes undesirable odors. Traps can be tied together with wire in groups of six or so to make handling easier. There are a few methods to dye your traps.

- **Logwood powder or crystals** can be used to dye traps. Put your traps in a large washtub or kettle over an open fire or a propane cooker. They should be submerged in the water with enough wire hanging over the side of the tub to retrieve the traps. When using a commercial logwood dye follow the directions on the package for the proper amount of water and logwood ingredients. Bring the water to a boil before adding the logwood. Let the traps soak in this solution for 30 to 60 minutes. The longer you leave the traps in the solution, the darker they will get. Stakes, drags, etc. can also be dyed and treated in this way.
- **Natural materials including black walnut hulls, alder bark, sumac berries and maple bark** contain tannic acid, just as logwood does. As an option to buying logwood, you can boil any of these natural ingredients for an hour before adding your traps.

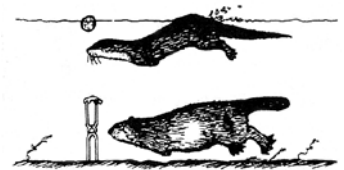

Ohio DOW Photo

Setting body-grip traps deep under water may allow an otter to go over the top of the trap, while most beaver will dive to the bottom and be caught.

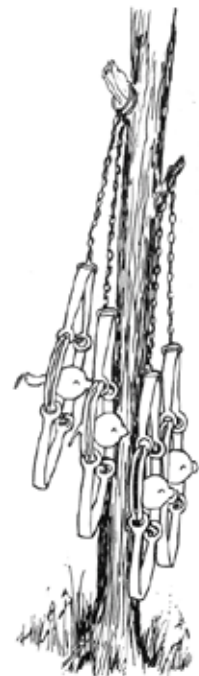

High temperatures may weaken your trap springs so it is best to lower the water temperature to a simmer after you add the traps. A propane cooker allows you to adjust the heat better than an open fire. Some trappers place the rebar stakes in the bottom of the barrel to keep the traps off the hotter bottom.

- **Speed Dips** are preferred by some trappers to color and protect their traps. **Note:** If you are using padded jaw traps, do not dip the pads. No fire is needed with dips. These products are fast and simple. Speed dips are available in either petroleum-based or water-based formulas. For **petroleum-based dips**, add unleaded gas or lantern fuel to the dip according to the directions. **For water-based dips**, add water to the dip according to the directions. Then you simply dip your pre-rusted traps in this solution and then hang them outside to dry. You will get a harder and more even coating if you use petroleum-based dips when the air temperature is above 70 degrees F. and the humidity is relatively low. Always read and follow manufacturer's directions. Some K-9 trappers shy away from petroleum based speed dips for fear that the gasoline smell will stay on the trap and the K-9's will smell this and not be attracted to the set.

Cage traps can easily be protected for many years by dipping them in speed dips. Purchase a plastic tub that is large enough to accommodate your largest cage trap. Mix enough dip together to cover half of the cage trap then roll your cage trap in the solution until it's sufficiently covered. Hang out to dry for several hours before storing.

Excess speed dip can be stored in a clean, sealable container and saved from one season to the next.

Waxing

Waxing is another way to protect traps from further rusting and make them operate faster. There are two common methods to wax traps:

- 1) Submerge traps in boiling water in a pot. Place commercial trap wax in the water and let it melt. The wax will float.

OR

- 2) Melt pure commercial wax with no water in a pot.

Then for both methods use a stick or hook, and slowly and carefully lift the traps out of the water one at a time. The traps should come out with a thin, even coat of wax. Shake the traps to remove excess wax. If the wax is too thick or too heavy, put the traps back in the pot and allow them to heat a bit longer before removing them.

Exercise caution when waxing, especially when using pure wax, because trap wax is extremely flammable. Wax can catch fire, or cause severe burns if it splashes on you.

No matter how you wax traps, make certain you keep the wax and the container free of odors. Furbearers have a keen sense of smell. If your traps have odors on them the furbearers may shy away from your sets. If the odor is an attractive one, the furbearer may dig it up and ruin your set.

Never wax a body-grip trap. It makes them very sensitive and dangerous and they may spring unexpectedly while they are being set. Speed dips or dyeing is acceptable for body-grip traps.

Once you have waxed or dipped a foot-hold trap, you must clean the end of the dog and the pan notch. If you do not remove the dip/wax, the trap will not stay set. Use a file to clean the wax or dip off these parts. Another technique to remove wax is to use a propane torch to melt the wax, then briskly rub it off with a rag. With this method there is no chance of removing the dye and allowing rust to form on the dog or in the notch.

Storage

After your traps are degreased, dyed and waxed they should be hung in a clean, well-aired area away from foreign odors. An ideal location is an open woodshed away from the house. Every effort should be made to prevent contamination of your clean traps with lure, bait, human scent, gasoline, oil, smoke or blood. It is a good idea to wear gloves when handling clean traps. Traps can also be stored in plastic storage containers that seal tightly. **Never oil or grease a trap.**

Metal or wood cage traps should be stored in open air and wooden box or cubbies should be allowed to weather before use.

Setting Traps

It is important that you develop skills when setting traps so that you can understand the way they work and use them safely. Working with an instructor, or an experienced trapper, select at least one type of live-restraining trap and practice setting it. Have your instructor or mentor show you how to release the trap safely. Practice with your instructor's help until you can do it correctly.

With practice, you will get comfortable setting traps. On the trapline, you will need to wear gloves for warmth, and to protect the trap from human odor, if you prefer. It is a good idea to practice while wearing the same type of gloves you will use when making sets.



Ohio DOW Photo

Dirt hole set.



Ohio DOW Photo

Trap placement is an important selectivity consideration.

Location.
Location.
Location.



Ohio DOW Photo

Avoid trails used by people and domestic animals.

Use the selectivity matrix in Appendix A to identify techniques relative to capture device type and design.

Practice setting and releasing a body-grip trap. Smaller body-grip traps have springs that can be compressed by hand. On doublespring models each spring can be compressed and then held with a safety hook that can be released once you have your trap in place.

Use setting tongs or chain setters to set body-grips size #120 and larger. This tool uses leverage to compress the springs and fasten the safety hook. You should then use a body-grip safety gripper to keep larger traps from firing shut while you are finishing your set. Setting tongs or chain setters should always be within reach when using large body-grip traps.

Selective Trap Techniques

The next several chapters will expand on selective trapping techniques including trap location, trap placement, trap adjustment, and how a bait or lure you choose can influence selectivity.

Trap location is the first consideration for selective trapping. Each species of furbearer lives in a certain kind of habitat, eats certain kinds of food, and follows certain habits. Use this knowledge to find the best places to set your traps.

Once you have found a good location, your trap placement can influence what species the trap set will catch. In addition, sticks and rocks can help you make selective sets. Examples include:

- If you make a muskrat set at the edge of a stream you can avoid ducks and other water birds by sticking branches out of the stream bank above the trap. Muskrats can pass below the branches.
- You can make a rock cubby for raccoon that will keep most dogs from approaching the trap.
- A few small stones can be used as foot guides at land sets to help make the animal put its foot on the trap pan.

Pan tension is an important consideration as well. Try one pound of pan tension for gray fox, two pounds for red fox or bobcat, four pounds for coyote, and six pounds for beaver.

Trap placement in relation to lure, bait, or other attractors is another factor in selective trapping. At a dirt-hole set, for example, try placing the trap 7 inches from the hole for fox, and 12 inches for coyote. This will vary some as to where the bait or lure is placed.

Chapter 8 Review – Traps

Objective - Students demonstrate the ability to identify types of traps, prepare traps for use, and safely operate traps.

Identify traps as kill-type or live-restraining devices.

1. Body-grip traps are _____.
2. Foot-hold traps and cage traps are _____.

Identify live-restraining traps, including longspring and coil spring foot-hold traps, guarded traps, enclosed foot-hold traps, and cable restraints.

3. Name each of the capture devices shown below.
 - a. Enclosed Trigger
 - b. Longspring Foothold
 - c. Coil spring Foothold
 - d. Cable Restraint
 - e. Guarded Foothold (Stop loss)

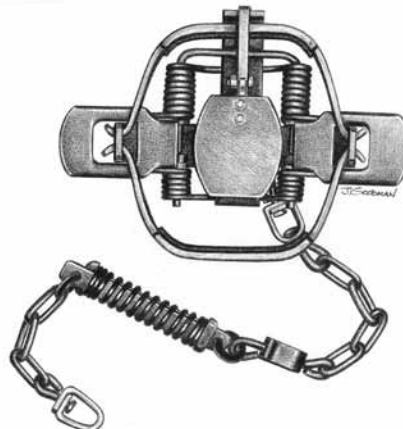
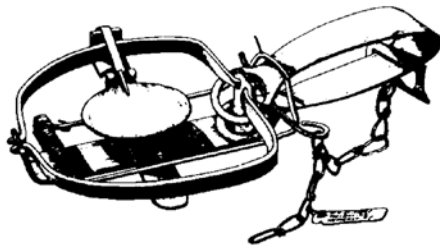
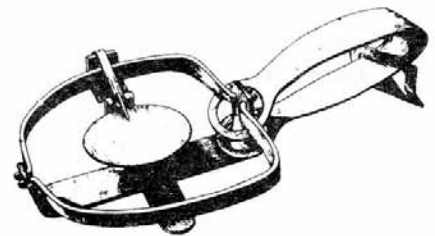
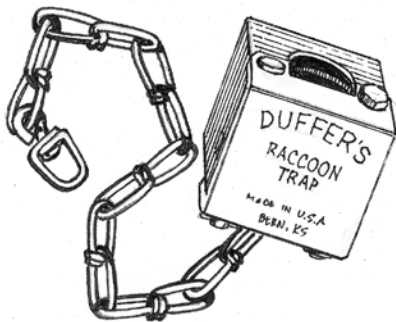

4. Label the parts of the trap shown.

- a. Dog
- b. Coilspring
- c. Pan
- d. Jaw
- e. Lever
- f. Baseplate

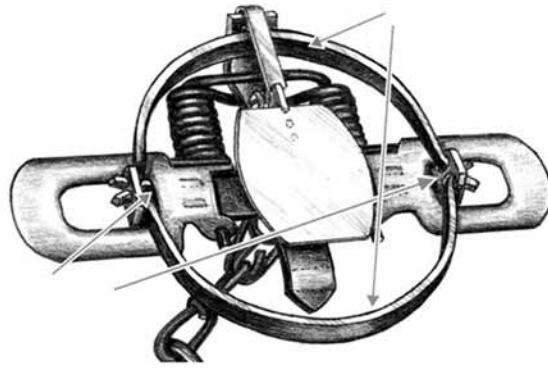

Identify jaw frame characteristics and modifications including plain jaws, padded jaws, offset jaws, double jaws, and laminated or wide jaws.

5. Name each of the jaw frame types shown below.

- a. Plain Jaw
- b. Padded Jaw
- c. Offset Jaw
- d. Double Jaw
- e. Laminated Jaw

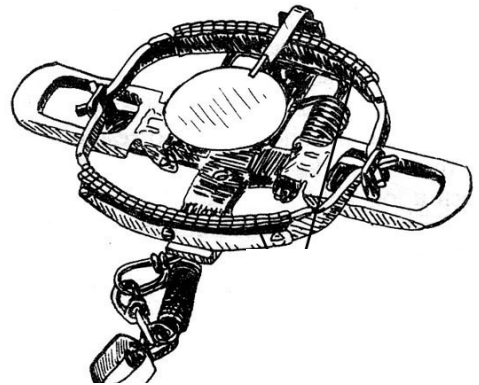
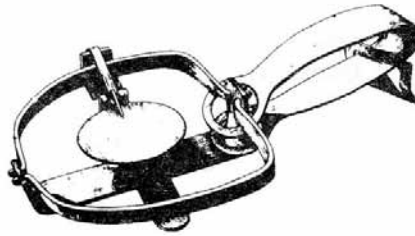
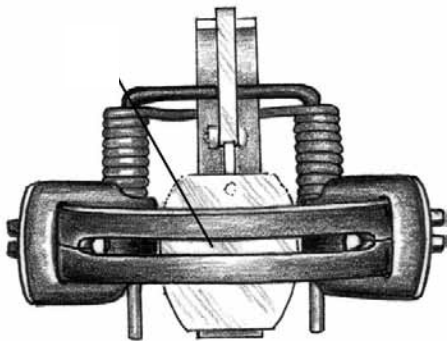

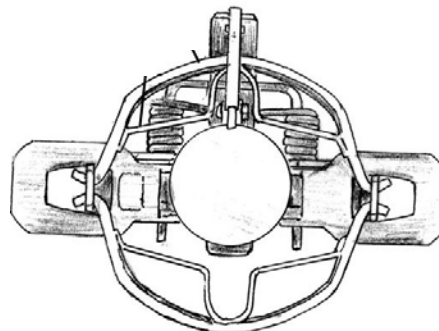
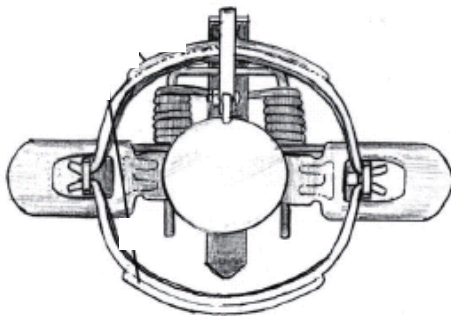

Know that foot-hold traps can be used in submersion sets for muskrats, mink, river otter, raccoon and beavers.

7. Label the parts of the body-grip trap shown.

- a. Dog
- b. Jaw
- c. Trigger
- d. Safety Catch
- e. Tag
- f. Trigger Wires
- g. Spring

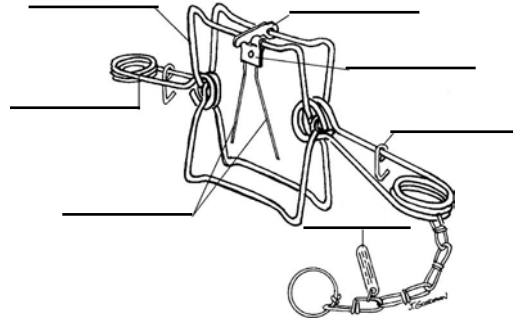

8. List four anchoring systems.

- a. _____
- b. _____
- c. _____
- d. _____

Identify live-restraining cage traps and kill-type colony traps for use in submersion sets.

9. Match the two traps below with their name.

- a. Live-restraining cage trap
- b. Kill-type colony trap

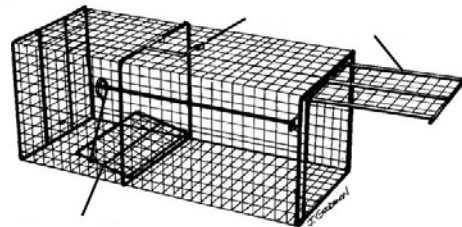
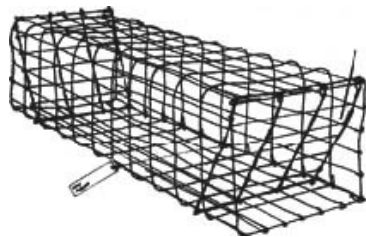

Explain how swivels are used and why they are important.

12. Swivels reduce the chance of _____ by allowing a trap to move freely in the same direction as the animal's foot.

13. _____ can be inserted in the chain and are used to help hold the animal and reduce leg and shoulder injury

Chapter 9

Trapping Equipment



Objective - *Students identify essential and nonessential clothing and equipment used to set traps and run a trap line.*

Introduction

Before setting any kind of trap, you need to acquire the basic trapping tools. There are many factors (weather, terrain, target species) that determine what tools will be needed. The type of trapping will also influence the tools you will need. Some tools are specific to water or dryland trapping, while others can be used for both.

As a recommendation, first-time trappers should start out with the basic gear needed to trap. Trapping equipment can be expensive, so buying used is a good choice. BUT, use caution. Used waders or hip boots may leak; used traps may be missing parts; or trap springs may have weakened. With experience, you will develop a better sense of gear needed and where to get good prices.

Basic Trapping Equipment

- **Trap Tags** – Trap tags are required to be attached to all traps in Wisconsin including: cable restraints, cable snares, cage traps, and colony traps. The trap tag must be a metal tag. Copper, brass or aluminum is suggested because they do not rust. Tags can also be purchased commercially for a small cost and are usually better quality and less work than homemade tags. **Tags must be stamped or engraved legibly with the name and address or the DNR Customer ID # of the operator.**
- **Packbasket, Bucket or Heavy Bag** – All trappers need something to carry their equipment in. Any of these items can be used. Lure and bait is usually carried in a separate pouch, container or in the trapper's coat pocket so odor is not spilled or spread on to the other trapping equipment.
- **Hatchet, Small Axe or Pocket Saw** – Every trapper has the need for a type of hatchet or cutting tool on their trapline to cut limbs, drive stakes, chop ice or even to make certain sets. The hatchet or axe can be a very important multi-purpose tool at times.



Mike Kortenhof

Trapper dressed in layers.

Water trappers will need hip boots or waders



Chris Tischeafer

Metal trap tags are made from brass or copper. The information is stamped or engraved into the metal and is permanent.

- **Knives or Multi-Purpose Tools** – Folding lockback knives or multi-purpose tools are recommended for trappers. You will find many uses for a knife on the trapline.
- **Trowel or Digging Tool** – Almost all sets require some type of digging. Trowels are used to make dirt hole sets on dryland and pocket sets on water. There are a few different styles of trowels.
- **Wire and Galvanized Cable** – Wire and/or cable has many uses on the trapline. Wire can be used to hold traps, baits or cubbies in place. It can also be used to support cable restraints on land and cable snares in water, repair chains when you're in a pinch or even make a drowning set. Galvanized multi-strand aircraft cable (normally 3/32" or 1/8" diameter) can be used to make submersion sets and to fasten traps. CAUTION: Wire and cable can weaken after use. Be sure to periodically check for kinks, nicks or fraying.
- **Pliers and Cable Cutters** – Pliers are used for cutting wire and adjusting traps. A cable cutter is needed if you use multi-strand aircraft cable for cable snares, cable restraints or anchoring systems.
- **Trap Stakes, Drags or Grapples** – Staking is very important whether you are a dryland or water trapper. You must be sure to stake strong enough for the largest animal you may end up catching. Steel stakes (rebar) or earth anchors (disposable stakes) are used to anchor traps. You may need to use drags or grapples in certain sets. Please refer to Dryland Trapping Equipment and Water Trapping Equipment further in this chapter for specific details on staking.
- **Lures, Scents and Baits** – Most sets have some type of lure, scent or bait applied to them to be an attractor to the furbearer you are targeting. Keep these items separate from your other trapping equipment to eliminate the chance of contamination.
- **Spare Parts** – It is essential to carry extra spare parts including swivels, S-hooks, trap tags, rivets, stake swivels, safety hooks and other parts or tools associated with your trapline along with you in case there is an immediate need to repair or change out any broken or contaminated traps or equipment.

Dryland Trapping Equipment

- **Dirt Sifter** – A dirt sifter is a frame about 8"x 10"x 3" with a quarter inch mesh screen or hardware cloth tacked on the bottom. Most commercial sifters are metal. Some trappers make their own out of wood. The sifter is



Hammer and hatchets



Bucket, bag, and pack basket



Ohio DOW Photos

Cable cutter and pliers



Earth anchors.



Dirt sifters, gloves, stakes for land trapping



From "Missouri Cable Restraint Training Manual." Copyright 2004 by the Conservation Commission of the State of Missouri. Used with permission.

Catchpole



Chris Bezio

Trappers use a variety of gloves to keep dry and warm. Some canine trappers use separate gloves for handling their traps. This keeps other scents from getting on the trap.

Many trappers work hard to avoid contaminating their trapping areas with unusual scents or human odor.

used to cover traps with fine soil. Sifters remove rocks, chunks of dirt or twigs or anything else that could interfere with the trap closing properly. It also adds a natural appearance to the set.

- **Kneeling Pad** – Some trappers use a cloth, canvas, or rubber pad to kneel on when making lands sets. A rubber kneeling pad works well as an odor barrier.
- **Stakes or Drags** – Soil conditions, terrain and cover type are all factors that determine what type of staking should be used at each set. Steel stakes (rebar) and earth anchors, or disposable stakes, work well and have the advantage of holding the animal at the set so it can be easily located. The length of the stake varies depending on the texture of the soil you are pounding into and the largest size of animal you could expect at your set. In some cases cross-staking may be necessary. In areas where the trapper is unable to drive in stakes or, if once caught, the trapper wants the animal out of sight, then drags and grapples should be used. The best drag to use is a metal grapple attached to the trap with a longer length of chain. This allows for easy concealment. Drags should only be used by experienced trappers or under the supervision of experienced trappers.
- **Gloves** – Some trappers use a pair of cloth or rubber gloves when making their dirt sets to keep human scent off of their traps. They may have another cloth pair or just use their bare hands when baiting their sets. Be sure not to mix your gloves or to get any bait, lure or other odors on your setting gloves.
- **Rubber Boots or Waders** – Some trappers have a preference to wear rubber boots and set traps from a squatting position so only their rubber boots are in contact with the ground. Others prefer hip waders so they can kneel while making their set.
- **Catchpole** – Many trappers carry a catchpole which is used to hold an animal so it can be safely released or **dispatched**. A catchpole is an essential tool for the land trapper. Also a good tool to have on board when water trapping if otter are present.
- **Pan Cover** – A pan cover is used by many land trappers to keep dirt and debris from getting under the trap pan and preventing it from going off. Wax paper, screen, plastic or plastic baggies and clean patches of cloth are items that can be used for pan covers.
- **Trapper's Cap** – A trapper's cap can be used instead of pan covers. This device temporarily fits over the trap pan while dirt is packed inside the jaws. When it is removed it leaves the area beneath the pan free of dirt.

- **Underalls** – Some trappers use pieces of foam rubber, fiber silk batting or fiberglass insulation cut to the shape of the trap pan and to the thickness of the space under the pan. This is another way to keep dirt and debris from getting under the pan.
- **Pre-Sifted Dry Wax Dirt or Anti-Freeze Flakes** – Pre-sifted dry dirt, waxed dirt, propylene glycol and/or anti-freeze flakes come in handy when the weather gets below freezing for dryland foot-hold sets. These items help to keep the dirt from freezing and allow your trap to work properly.

Water Trapping Equipment

- **Gauntlets** – Most water trappers use some type of rubber glove when trapping. The most common is the gauntlet that covers the arm up to the shoulder to keep dry in cold weather. Some gauntlets are even insulated.
- **Rubber Boots or Waders** – Depending on the depth of the water you will be trapping in you will need rubber boots or hip waders for water trapping. Some trappers even use chest waders to keep them better protected and dry from the elements.
- **Stakes or Drags** – Wooden stakes are sometimes preferred over metal when water trapping because they are easily accessible on the shoreline and blend in more with the scenery. Metal stakes are more durable though. When trapping for beaver wood stakes should be pre-cut and dried or be a dead stake or limb because beaver tend to gnaw on green stakes. Wood laths work well when trapping for mink and muskrat using body-grip traps. Drags are used in water sets where the soil is too rocky or too loose to hold a stake. Drags used in water sets are usually heavy objects like bricks, pieces of iron or rocks.
- **Drowning or Submersion Wire Slide Lock** – A drowning lock is a simple one-way slide lock designed to use when water trapping. The drowning lock is on a cable or wire with one end staked in shallow water and the other end in deep water. When an animal becomes caught in the trap it tends to dive for deep water. The device allows the animal to go only into deep water and not return. Before staking, double check the **drowning or submersion device** to be sure it is set up going in the right direction. Swivels can also be used as a drowning device. Drowning or slide wires can be made in various lengths to meet your needs. Common lengths include 5, 10 and 15 feet.
- **Ice Chisel or Spud** – An ice spud is used for cutting holes in the ice for trapping muskrat, mink and beaver.



Rick Tischeafer

Stakes



PFD stands for Personal Flotation Device, an inexpensive item that can save your life!

- **Trapping Staff** – A staff is used by many water trappers to help them navigate through muddy shorelines. A staff can also be used to check water depths when wading, detect underwater muskrat dens and runs, and with a hook on one end can retrieve traps from deep water especially under the ice. The use of a hook is much safer than reaching under the water to feel for a missing trap and becoming caught. A trapping staff of the proper weight and strength can also be used in the **dispatch** of animals caught in live-restraint traps. Painting a section of the staff florescent orange makes it easier to locate when leaving a set.

Additional Trapping Equipment

- **Plastic Flagging** – Plastic surveyor flagging is used to mark trap sites or other areas of interest.
- **Setting Tongs** – A setting tongs is used to set body-grip traps. This tool saves the wear and tear on your hands when running a long line.
- **Safety Gripper** – A safety gripper is placed on the jaws of a body-grip trap once it's set to prevent it from going off when you are placing your body-grip traps. Just be sure to remove the safety gripper and wire back the safety hooks on the trap before finishing the set.
- **Stabilizer** – A stabilizer is a support system for body-grip traps that holds the trap solid in a specific area instead of having to try and stabilize it with sticks.

Safety Equipment

Safety should always be a priority when trapping. Some items to carry with you at all times when you trap include a **flashlight**, a **cell phone**, a **map**, **waterproof matches**, and a **compass**. Keep them in the same place at all times so you know where to reach for them in case of emergency.

Trappers need **clothing** for a variety of weather conditions. Weather conditions change during the trapping season, or even during a single day while on your trapline.

Dress in layers. You can remove some clothing if temperatures rise during the day. When you water trap or trap in cold weather, wearing wool clothing is a good choice. **Wool** retains heat even if it gets wet. Wool also allows perspiration to evaporate, so you don't get damp and cold.

Carry a **rain suit** along with you in your vehicle when you trap. This will help to keep you dry when raining and block off the wind on windy days.

Keep your clothes **clean and free of unusual scents**. Fox and coyote are especially wary of certain scents. Try to wear clothing that is **quiet**. Some kinds of clothing are noisy when you walk. If you are quiet you will see more wildlife.

Visibility to other people is important during certain hunting seasons. Make yourself easy to see and identify. Trappers may be concerned about being too visible because of concern about trap thieves. From a distance, most people will assume you are hunting if they see **hunter orange clothing**. Your personal safety is more important than the potential loss of a few traps.

Some water trappers wear a **life jacket** or vest in case they fall into deep water. An inflatable personal flotation device that takes up less space could also be used with or instead of a life vest. If you need more flotation you can pull the string on an inflatable, which releases gas into the vest and expands it. A mouth tube should be available to use in case the gas canister doesn't work.

All trappers should have **warm hats**. Body heat can escape through your head if you do not wear a hat. A hat also protects your head and face from sun and wind.



John Olson

Paul Peterson and Steve Hoffman setting traps for BMP research.

Chapter 9 Review – Trapping Equipment

Objective - Students identify essential and nonessential clothing and equipment used to set traps and run a trap line.

1. _____ are required to be attached to all traps in Wisconsin.
2. _____ are used to make dirt-hole sets on dryland and pocket sets on water.
3. A _____ is used to cover traps with fine soil.
4. As an essential tool for the land trapper, a _____ is used to hold an animal so it can be safely released or dispatched.
5. When using a _____ or _____, always check to be sure it is set up going in the right direction before you stake it.
6. Trappers need _____ for a variety of weather conditions.



Objective - Students explain responsible use of lure, bait, and urine to attract furbearers to sets.

Introduction

Baits, scents and lures are used as attractants or fear reducers at or near sets. Effective use of bait, lure, and urine will increase your catch and help you avoid non-target animals. The more you learn about an animal and its habits, the better you will be at using lure, bait, and urine.

Use Bait, Lures, and Urine to Attract Furbearers

Bait, lure, and urine can be used alone or in combination to help you trap furbearers. Scents should match the interests of the animal you are trying to catch, often times reducing interest from other mammals, especially domestic pets.

Baits

Baits are used to attract animals to your sets and make them stay longer. Your choice of bait and its placement is based on the furbearer's food source and eating habits. Baits can be chunks of meat and fish, or plant food such as corn, carrots, and apples. Meat and fish bait may be fresh, tainted, or liquid in form.

Bait must be used carefully to prevent catching non-target wildlife or domestic animals. Pay close attention to trapping regulations concerning bait. Uncovered flesh baits are attractive to hawks and owls, which hunt by sight. Lightly covered flesh baits work for furbearers because they have a keen sense of smell. Baits such as corn may attract a variety of non-target animals. **In Wisconsin, a trap or device cannot be placed within 25 feet of sight exposed bait consisting of feathers, animal flesh, fur, hide or entrails.**

Lures

Lures are used to attract animals to your sets from a distance. Lures are classified as gland, food, or curiosity attractants. Gland lures are made from anal or other glands of the target animals. Gland lures appeal to an animal's sexual attraction or territorial instincts. Food lures or scents appeal to their desire to eat; these lures are used in liquid, semi-liquid, or solid form. Curiosity lures appeal to a furbearer's instinct to investigate something unfamiliar. Common curiosity lures include: beaver **castor**, skunk essence, and cheap perfume.



Ohio DOW Photo

Baits - Canned fish, apple, and carrot

If you find a dead animal, do not set traps there, you may catch non-target animals. Wisconsin, and other states have laws that restrict the distance between exposed bait and the capture device. Know the law.

Visual attractants, where legal, are sometimes used. Bobcat, for example, may be attracted to strips of cloth or pieces of metal fluttering in the breeze.

Generally, food lures are most effective in the early part of the trapping season; gland lures become more important later in the season when the animals are looking for mates; and curiosity lures may work at any time in the season, especially when the animal is not hungry or looking for a mate.

Urine

Urine is often used for trapping bobcat, fox and coyote. Like dogs, fox and coyote mark their territory by urinating on various objects. Urine triggers a territorial response that may encourage a bobcat, coyote or fox to investigate your set.

Some trappers enjoy making their own lures and attractants. It is part of the challenge of becoming a successful trapper. Commercial lures work, but if a certain kind is used frequently, animals may become wise to the scent and avoid it.

The Responsible use of Baits, Lures, and Urine

The use of bait, lure, and urine is a key factor in selective trapping and varies by time of year, location, and the type of furbearer you want to catch. Each furbearing animal will respond to certain food smells. Glandular lures can appeal to a specific animal's mating urges. Avoid other baits that might attract dogs or cats. For example, fish might attract cats if you are trapping near homes that have pets. ***Never use pet food for bait!***

Odors of lures and baits should be kept off the traps and the soil covering the traps. Lure contaminated traps or soil may cause some furbearers, like fox or coyote, to dig the traps out.

The presence of non-target species or domestic animals will also affect your choice. Remember, each non-target animal that comes to your set reduces your chances of catching the animal you want.

In the first ten years of BMP restraint trap research in the United States 13,294 animals were caught during 300,000 trap nights with only 1.4% being dogs. All dogs were released alive with little to no injury!

NOTE: Beginning trappers may want to use commercial lures until they develop their own. Experience and experimentation are critical for determining which lures are effective in a variety of situations.

Be conservative with baits, lures, and scent. Too much smell will take away the curiosity of the set and the animal will be less attracted to the area. Very little is needed, just enough to be carried by the wind (a few drops).

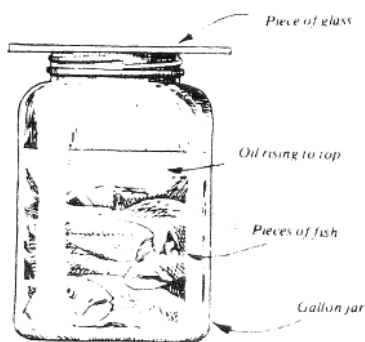

Fish Oil. Use a piece of glass on top rather than screwing on a lid. This allows gases to escape rather than exploding the bottle!

Never use pet food for bait!

Select Lure Recipes

Coon Lure

1 pint Fish Oil
4 oz Molasses
4 drops Anise Oil

Fox Lure

4 oz Fish Oil
Anal Glands from 4 Fox (Ground)
2 drops Skunk Essence
½ Tsp Tonquin Musk

Canine Gland Lure

1 oz Fox Glands
¼ oz Tonquin Musk
½ oz Glycerin
½ oz Beaver Castor
1 oz Fox Urine
Add 2 drops Skunk Essence for cold weather

Muskrat Super Carrot

½ oz Carrot Seed Oil
2 oz Carrot Oil
1 oz Amberette Oil
2 oz Glycerin

Mink Lure

2 oz Mink Glands
2 oz Muskrat Glands
1 oz Beaver Castor
10 drops Tonquin Musk

Muskrat Sweet Flag

1 oz Calamus Oil
2 oz Sweet Flag Oil
1 oz Aberette Musk Oil
2 oz Glycerin



Ohio DOW Photo

Urine and lures

Bait and lures come in a variety of textures and smells.

Chapter 10 Review - Using Baits, Lures and Urine

Objective - Students explain responsible use of lures, baits and urine to attract furbearers to sets.

Explain when and how to use bait, lures, food lures, curiosity lures and urine to attract specific furbearers.

1. _____ are used to attract animals to your sets and make them stay longer.
2. _____ are used to attract animals to your sets from a distance.
3. NEVER use _____ for bait!
4. _____, _____ & _____ can be used alone or in combination to trap furbearers.
5. In Wisconsin, a trap or device can not be placed within _____ feet of sight exposed bait consisting of feathers, animal flesh, hide or entrails.

Chapter 11

Water Sets

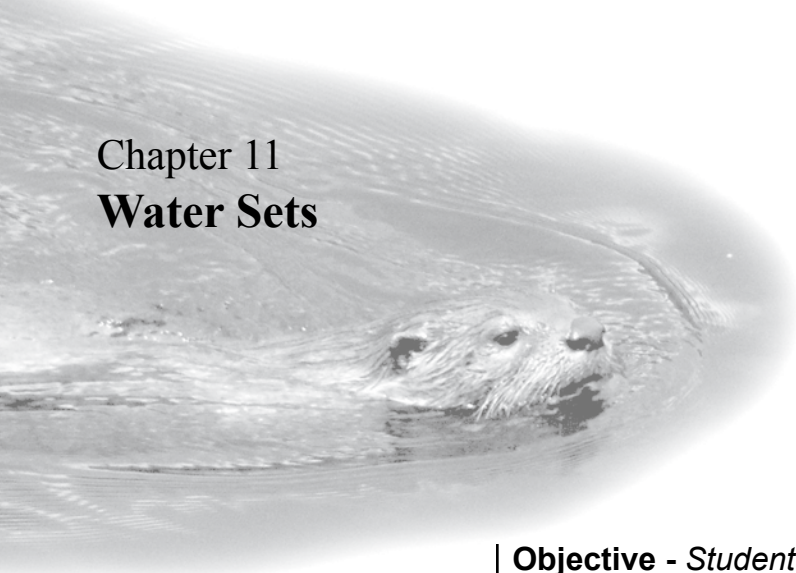

Objective - Students demonstrate an understanding of the procedures for making safe, effective, and selective sets in or near water.

Introduction

First-time trappers can focus on water sets for muskrat and mink. This is an excellent way to gain knowledge and experience while using a minimal amount of equipment.

Water trapping saves on startup expenses and avoids most non-target animals. It also avoids the need to **dispatch** animals held in foot-holds or other live-restraining devices when connected to submersion systems. When a trapper becomes skilled at trapping muskrats and mink, additional equipment can be purchased to use for larger furbearers such as fox, coyote, raccoon, beaver, and otter. Generally equipment used for these furbearers is more expensive than the small traps used for muskrat and mink.



Junior Prudlick

Reasons to start with water sets using kill-type traps and techniques.

- No need to dispatch
- Reduces chance of catching a non-target animal
- Less chance an animal will escape



Jolene Kuehn

Best Management Practices for Water Sets

Trappers, biologists, veterinarians, and researchers have evaluated many traps. BMP traps have been tested for:

- Animal welfare.
- Efficient ability to capture and hold animals.
- Selectivity for furbearers.
- Practical use in the field.
- Trapper safety concerns.

Body-grip traps of suitable size or foot-holds in a submersion set should be used whenever possible for water trapping. Cable snares are also used for water submersion sets.

It is beneficial for beginning trappers to start with water sets as they are easier to make than dry land sets. Due to the location of the sets, water trapping is selective for semi-aquatic species and avoids most non-target animals.

The use of body-grip traps and properly made submersion sets result in a furbearer's death. Additionally, these sets make it unlikely a furbearer will escape.

Submersion sets frequently are used for semi-aquatic furbearers (muskrat, mink, river otter, and beaver) and raccoon. Semi-aquatic furbearers in or near the water tend to dive below the surface of the water as a "flight" response to danger. Properly made submersion sets allow the captured animal to dive but not return to the surface. The lack of oxygen causes the animal to die.

If for some reason submersion does not occur for a target furbearer, blunt trauma to the head is accepted by the American Veterinary Medical Association as humane **dispatch**.

Describe Two Basic Techniques for Making Submersion Sets

Use submersion trapping techniques whenever possible for semi-aquatic furbearers. Submersion sets also work well for raccoon. Using a heavy trap that will prevent the animal from resurfacing is recognized as a submersion set (though making sure it is properly staked is important), but a trap that is heavy enough for a muskrat may not submerge a large mink or a raccoon, so care must be taken when setting that way. The two most common and recommended techniques for making submersion sets with foot-hold traps are:

- Sliding cable technique
- Tangle stake technique

The sliding cable technique:

- Prior to the trapping season, cut lengths of galvanized cable (long enough for the captured animal to reach deep water) and slide a "one way" lock onto the cable. Use double ferrules to make closed loops on each end of the cable. These premade, one-way sliding wires are ready for use.
- When you find a good trap location, make sure the sliding lock points toward the deeper water. (The lock will prevent the animal from swimming back.)
- Use a heavy object such as a rock for an anchor or use a stake you can push into the stream bed in deep water that will not pull out easily.
- Slide a stake through the closed loop on one end of the cable.
- Put the anchor or the stake in water deep enough to fully submerge the intended furbearer.

Small body-grip traps are good choices for trapping muskrat and mink in shallow water. Set body-grip traps at the entrance to a muskrat den or in a muskrat channel.

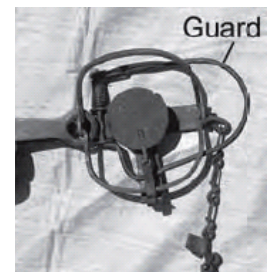

Guarded foot-hold traps are sometimes used for muskrat trapping where kill-type traps are not usable and the water is too shallow for a submersion set. The guard is designed to prevent muskrats from escaping.

Submersion Set - Before the set is finished, push the stake the rest of the way into the ground at the water's edge to keep the animal from tangling on the stake.

Sliding cable anchor - You can use a heavy object or a stake to anchor the sliding wire in deep water.

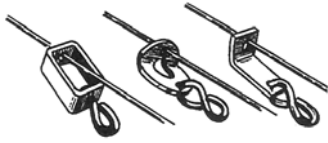

Illinois Department of
Natural Resources

Submersion system locks.

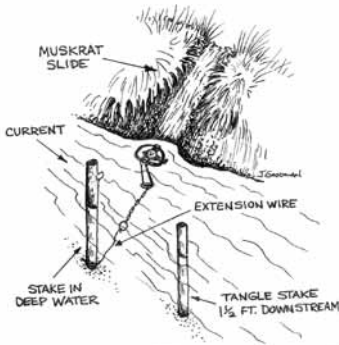

Joe Goodman

Muskrat slide.



Muskrat Hut.

Some waterfowl refuge systems restrict trapping near muskrat lodges in Wisconsin. Know the regulation where you intend on trapping.

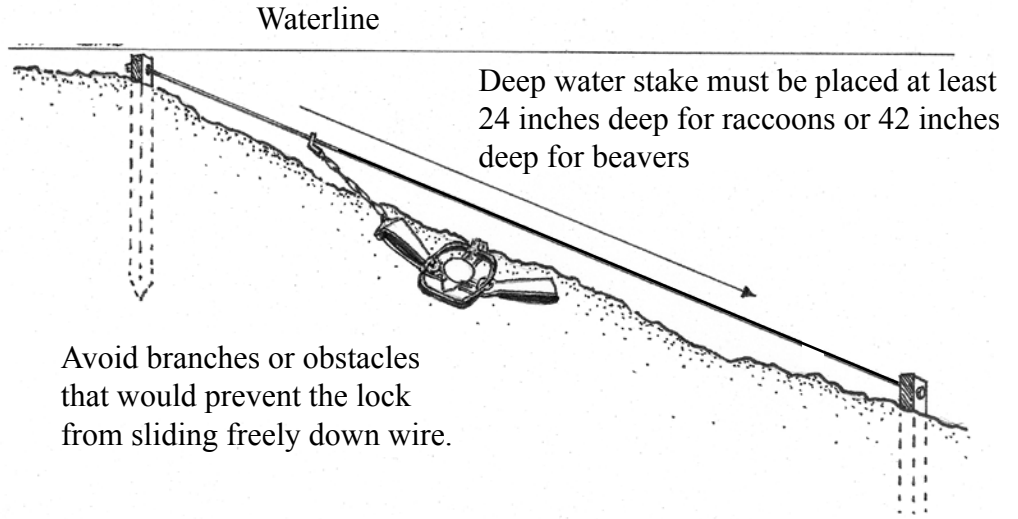

Avoid branches or obstacles that would prevent the lock from sliding freely down wire.

- Bring the cable to the shoreline (making sure the sliding lock is in the correct direction) and slide a stake through the closed loop on this end. Drive the stake in the bank near your set so that the cable is tight.
- Make your set.

When the animal is trapped it will swim to deep water and remain there.



Tangle wire technique:

- Attach a length of 11 or 12ga wire to a long stake.
- Attach the trap chain to the wire with an S-hook.
- Stake the trap securely in deep water, put another stake on the deep side of the first stake or downstream.
- When the animal swims the wire cable will force it to swim in a circle, wrapping the wire around the two stakes; the weight of the trap will soon pull the animal under.

In Wisconsin and many Midwestern states, a special muskrat trap, called a **colony trap**, is also used as a submersion set.

Common Water Sets

Runway Sets

When muskrats travel back and forth in shallow water they create a runway in the mud. Colony traps are a special type of cage trap designed to catch muskrats in a runway and keep them submerged. You can catch several muskrats at a time in a colony trap. There is a swinging door on each end. The door opens easily when a muskrat travels the runway. The door falls closed after the muskrat enters. There are specific regulations for using colony traps in Wisconsin. Be sure to check the annual trapping regulations prior to the beginning of the trapping season. In addition, make certain the trap is 100% submerged underwater to ensure quick dispatch. During cold weather, water levels may drop a bit at night because some water sources may freeze. In this situation, make sure colony traps are a few inches below the daytime water level.

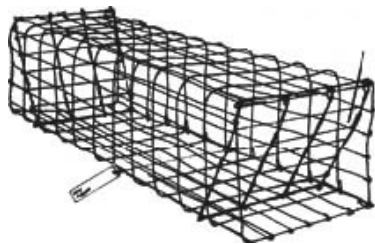

Body-grip traps are also used in runways. You can set more than one per runway if it's long and well defined, but space them so that the captured animal doesn't trigger nearby traps. Runways may easily be spotted through clear ice as there will be a trail of small bubbles defining the travelway.

Pocket Set

A pocket set is one of the most effective water sets for muskrats and mink. To make a pocket set, find a bank that is straight up and down. At the waterline start digging a pocket into the bank at a level where the bottom will be about two inches below the water. The pocket should extend one to two feet into the bank and angle up. Put the bait or lure above water level at the back of the pocket.

The pocket should be about six inches in diameter for muskrat or mink. Set a body-grip or foot-hold trap of the correct size for the animal you plan to catch.

How to make a Pocket Set



Ohio DOW

Dig pocket at water line.



Ohio DOW

Shave bank on both sides.



Ohio DOW

Put bait in pocket.



Ohio DOW

Place trap at pocket mouth.



Beaver take out - an area used by beavers and otters to enter or exit the water.

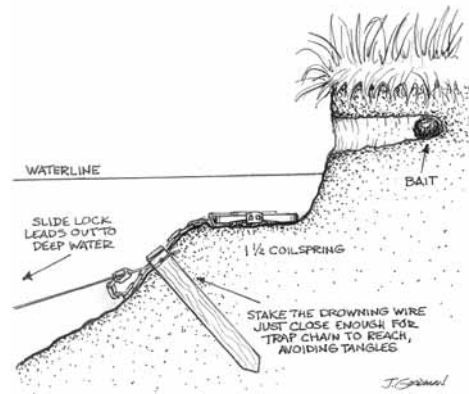

The trap can be placed at the mouth of the hole in case the animal doesn't want to go all the way inside. If you are in an area where dogs may be a concern do not use meat or fish bait. To avoid dogs you can place the trap well inside the pocket, or make the set under cover such as low-hanging branches or exposed tree roots.

Trail Set (Blind or Natural Set)

Furbearers use the same trails at the water's edge on a regular basis. Find a narrow spot on the trail to make your set. If you don't find a natural place for a trail set use logs or rocks to narrow the path. This is a good location for a small body-grip trap.



Brent Tees

Beaver dam. Foot-holds and body-grip traps may not be set closer than 15' to these active structures.



When setting in water, dig a shallow depression in the bank at the narrow spot. Set a foot-hold trap in the depression, bedding it firmly into the mud. Use the sliding cable or tangle stake technique to make it a submersion set.

You do not need to use lure or bait on a trail set. Trail sets are effective for muskrat, raccoon, mink, beaver and otter.

Cubby Set

Cubby sets are used for mink, muskrats and raccoon where the bank slopes too much to make a pocket set. If you find tracks on a sloping bank, make a cubby out of rocks, logs, or old boards. Place your bait or lure at the back of the cubby. You can use your foot or a trowel to make a depression for your foot-

hold trap at the entrance to the cubby. Use a submersion trapping technique with a slide cable or a tangle stake.



Muskrat lodge or bank hole set

Musk rats make dens in the banks of streams, rivers, lakes, and ponds just under the surface of the water. If you see chewed up pieces of vegetation floating on the water look for a den nearby. Musk rats also make lodges out of cattails or reeds in shallow water marshes. You will find openings around the base of the hut where you can make den sets. When iced over, den entrances will be identified by small bubbles. As the furbearer swims from the lodge or bank den, air within the fur is compressed out and floats to the surface and collects on the underside of the ice.

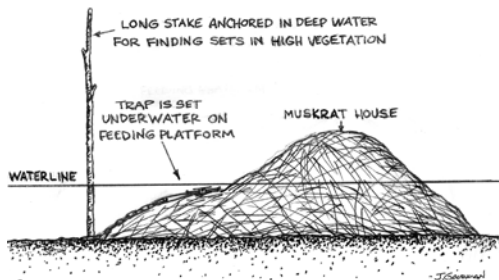

Muskrat lodge set.

Body-grip traps are the best choice for den sets. You can place small sticks in the upper jaws of the trap to hold it in an upright position.



How to make a Cubby Set



Ohio Dow

Cubby - Make the sides first.



Ohio Dow

Make the top of the cubby.



Ohio Dow

Place trap connected to submersion system at entrance.



Ohio Dow

Muskrat Den.



Ohio Dow

Den Set - Body-grip trap.



Ohio Dow

Den Set - Sticks hold trap in place and guide muskrat or mink.



Chris Tischaefel

Castor mound set with body-grip trap. Be sure these large body-grip traps are at least half submerged.

In preparation for winter, muskrats create push-ups for use after the water freezes. Push-ups look like miniature muskrat lodges and usually are only large enough for one muskrat. Muskrats use these to temporarily get out of the water and for shelter while feeding. The push-ups and lodges are critical habitat and important to the survival of the remaining muskrats.

Climb Out Set

Muskrat, beaver, and otter leave distinct trails, sometimes called slides, at the spot where they climb out of the water to feed. You can put a foot-hold trap just under the water where the slide enters. Use a tangle stake or sliding cable submersion technique. If there are many slides in a certain area, use bait or lure to encourage use of the slide protected with the trap.

Float Set

Muskrat often climb onto floating logs. You can take advantage of this habit by setting traps on logs or homemade platforms.

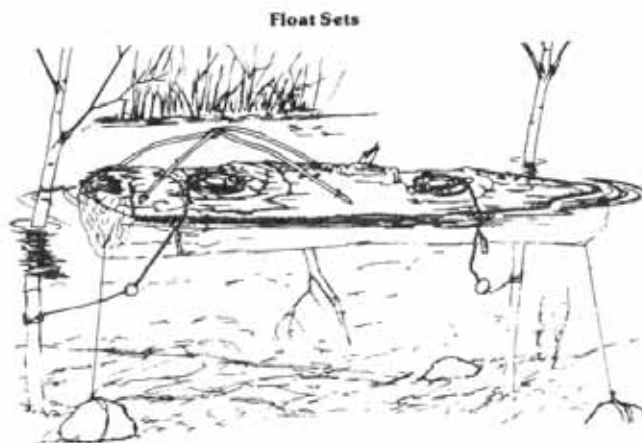

Make float sets in water more than a foot deep. Use muskrat size foot-hold traps on a chain or cable. When the muskrat is trapped it will enter the water and the weight of the trap will prevent the muskrat from reaching the surface. Place branches or sticks over the top of the trap to keep ducks or other birds from using the same float.

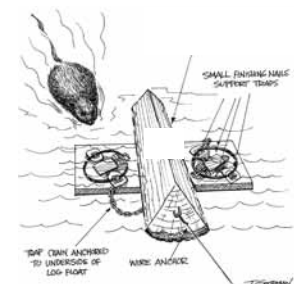

Spring Run Set

The place where a spring run or small stream enters a larger body of water is a good place to trap muskrat, mink, or otter. Use a foot-hold trap and submersion techniques.

Obstruction Set

An obstruction set is a variation of a trail set. Look for a tangle of tree roots, log piles, or similar obstructions on the bank that forces a mink traveling the water's edge to enter the shallow water. You can bed a foot-hold trap in shallow water using a tangle stake or sliding cable submersion rig. This is a blind set and no bait or lure is needed.

Scent Mound Set

Beaver make mounds of mud and mark them with **castor**. Conceal beaver sized foot-hold traps with a securely staked sliding cable submersion rig. If beaver are using the waterway, make a scent mound to imitate beaver activity and mark it with castor lure. Depending on conditions, a body-grip or foot-hold trap can be used in this set and are effective both late fall and spring.

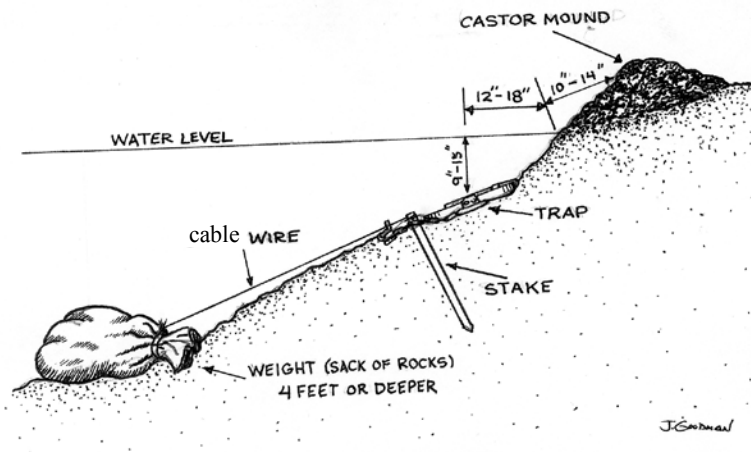

Channel Set

Muskrat, mink, otter, and beaver follow paths under the water called channels. This is a good place to set a submerged body-grip trap. These furbearers regularly enter confined spaces so they don't usually shy away from a body-grip trap in their path.

Place the trap at the bottom of the channel. If the channel is too wide you can arrange sticks or brush in a way to narrow the path and guide the furbearer into the trap. Use a blocking pole across the top of the trap to make the animal dive below it. Stakes and sticks are used to anchor the body-grip trap and position it correctly in the channel.



Chris Tischaefer

Body-grip trap with a beaver. Proper trigger configuration allows the trap jaws to close on the body just behind the head.

Spring Run Set



Use body-grip traps with bent corners to reduce fur damage.



Joe Goodman

Set body-grip traps so the trigger is on the bottom to reduce fur damage.

Body-grip traps with weak springs can cause fur damage.

If an animal is frozen in a body-grip trap, thaw it before removal to prevent fur damage.

Making a set under the ice for beaver is not for beginners. Find someone experienced to help you. Always trap with a friend or family member, especially when you are using large body-grip traps and working on ice!

WATER TRAPPING EQUIPMENT

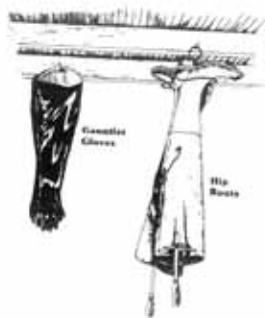

Open Water Beaver Set

An open water beaver set is made like a scent mound set, except that it is baited with fresh aspen or other food instead of castor lure. The set imitates a location where a beaver leaves water to eat and rest.

Otter Latrine (Toilet) Set

Otter regularly visit certain spots near the water called latrines. You will see piles containing fish scales and bones at otter latrines. Set a foot-hold trap in 3 to 4 inches of water at the spot where the otter travels in and out. Use a sliding cable submersion technique.

Under Ice Beaver Bait Set

You can catch beaver under ice using foot-hold, cable snare or body-grip traps. Make sure the ice is safe and have someone with you when you make these sets in case you need help.

Chop a hole in the ice near a beaver lodge or den. Wisconsin has a minimum distance the trap must be set away from the dam, so check the regulations. Attach the trap and the bait to a long pole and push it deep down into the mud under the water. The pole should extend well out of the ice. A trapped beaver should not be able to reach the hole in the ice where it can breathe.

Chapter 11 Review – Water Sets

Objective – Students demonstrate an understanding of the procedures for making safe, effective, and selective sets in or near water.

Explain the benefits of using traps that meet Best Management Practice specifications for water sets.

1. BMP traps have been tested for:
 - a. _____ welfare.
 - b. _____ ability to capture and hold animals.
 - c. _____ for furbearers.
 - d. _____ use in the field.
 - e. Trapper _____ concerns.

Describe three reasons new trappers should start with water sets using kill-type traps or submersion trapping techniques.

2. No need to _____.
3. Reduces chances of catching a _____ animal.
4. Less chance an animal will _____.

List two techniques for making submersion sets.

5. _____
6. _____



Chapter 12 Land Sets



Objective - Students demonstrate an understanding of the procedures for making safe, effective, and selective sets on land.

Introduction

Trapping on dry land presents many challenges to the knowledge and skill of trappers. You must know how to properly prepare your equipment, make selective sets, how to release non-target animals and humanely **dispatch** live animals.

The dirt-hole set, flat set, post set, and cubby set are commonly used for coyote, red and gray fox, bobcat, raccoon, skunk, opossum, and other furbearers.

Trap Placement Influences Animal Welfare and Selectivity

Avoid setting traps near homes or places that are heavily used by people and their pets. Trappers should choose set locations that:

- Minimize exposure to domestic animals and human activities.
- Prevent entanglement with fences or other objects that might result in injury.
- Are selective to capture furbearers.
- Avoid trails used by people.

Best Management Practices for Land Sets

Trappers, biologists, veterinarians, and researchers have studied many traps. BMP recommended traps have been tested for:

- Animal welfare.
- Efficient ability to capture and hold animals.
- Selectivity for furbearers.
- Practical use in the field.
- Trapper safety concerns.

Good Places for Land Sets:



Ohio DOW

Brush rows and fencerows.



Ohio DOW

Brush filled gullies and drainages.

Use selective techniques to avoid pets. If you catch a dog or cat, release it and notify the owner.



Ohio DOW

Steel and wood stakes.



Natalene Cummings

Cross-stake method.



Ohio DOW

Cross-stake fasteners.

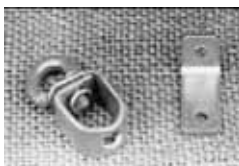

Ohio DOW

Stake swivels/
fasteners.

Good Locations for Land Sets

Good places for land sets include:

- **Brush rows and fence rows** that guide animal movements and provide rodents, birds, or other food for furbearers. Be aware, it is important when setting in these areas to avoid entanglement, especially when using cable restraints. Always consider where you are setting!
- **Brush filled gullies** that provide food and shelter.
- Areas **near farm lanes** that intersect changing cover types, pass through brush rows, or provide gateways to other fields.
- **Saddles** or draws between terrain features or areas where predators can observe prey or watch for danger.

Anchoring Traps on Land

Trappers must know how to anchor their traps properly to hold furbearers and prevent injury. Incorporate swivels, shock springs, and appropriate chain length to reduce the potential for injury. Traps are normally anchored with stakes, but sometimes drags, earth anchors or grapples are used.

Steel stakes are recommended. Stakes must be long enough to hold the largest animal that may be caught. Under most conditions they should be 18-24 inches in length. Even longer stakes are needed in sandy soils. For fox and coyote a more secure method is required to prevent the animal from pulling out the stake. You may need to use a double-stake swivel with the cross-staking method for a better hold. **Cable stakes** or **earth anchors** are another choice, but take time to dig them out when you remove your set.

In some terrain you may need to use drags or grapples. Drags and grapples allow animals to find cover nearby.

Shock springs are used on trap chains to help hold animals and prevent injuries. Use high quality shock springs of sufficient strength for animals you are trapping.

Swivels are important parts of your anchoring systems. Stake swivels and two or more chain swivels allow an animal to move freely without twisting the chain down to a point where it is easy for the animal to pull out of the trap or injure itself.

Bedding a Foot-hold Trap on Dryland

Traps must be properly bedded for land sets to work. Traps should be set level or slightly below the level of the soil around it. The steps for bedding a trap are:

- 1) Dig a hole slightly larger than the outside profile of the trap. The depth will depend on the amount of chain you need to conceal under the trap. When finished, the top of the trap should be covered by 1/8 inch of soil and the pan should sit slightly lower than the ground around it.
- 2) Test the hole to make sure your trap will fit and make adjustments if needed. Position and drive your stake at the front of the hole (the side nearest you) where the loose jaw of the trap can rest on it.
- 3) Place the trap chain in the trap bed, cover it with soil and pack it with your hand or fist.
- 4) Place the trap in the trap bed with the loose jaw resting level on the top of the stake. Twist the trap from side to side to settle it in the dirt.
- 5) Pack dirt tightly around the outside of the trap except for over the spring levers.
- 6) Use your fingers to apply pressure to each jaw and spring lever (one at a time). If you detect movement, add some soil or a small dirt clod under the low spot.
- 7) Put the cover over the pan (if used). Sift dirt over the trap until it's nearly level with the surrounding area.
- 8) Locate the pan by brushing away some of the dirt. When you know where it is, pack dirt around the outside of the pan using the back of your hand.
- 9) If needed, sift a fine layer of dirt over the set to blend it in with the surroundings.

The four-point system check includes:

1. Press on the loose jaw
2. Press on the other jaw
3. Press on a lever
4. Press on the other lever

*If the trap is wobbly, pack more dirt under that area and repeat the check.

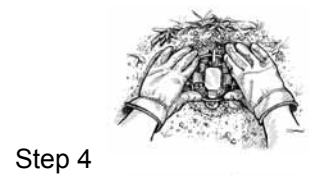
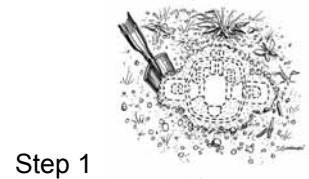

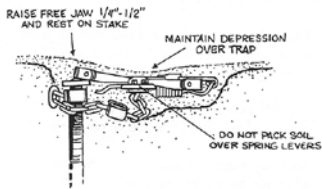

Bedded trap.

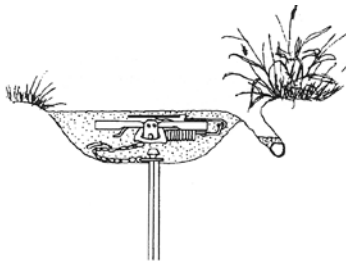

Dirt hole set.



Covering a Foot-hold Trap on Dryland

Generally, foot-hold traps set on land must be covered to hide them from furbearers. Dirt, leaves and grass can be used to cover your traps. The covering must not interfere with the action of the trap.

Leaves and grass will work when you set a trap for raccoon or opossum, which are not as wary as fox or coyote.

Make sure nothing gets under the trap pan, or the trap may not work. Likewise, make sure there are no objects above the jaws that might keep the trap from closing properly.

Crumple up a piece of wax paper and unfold it for a trap cover. Crumpling wax paper softens it so it won't make noise when the animal steps on it. Using a small amount of fiberglass insulation between the underside of the trap pan and the baseplate also serves the same purpose as a pan cover.

Use a dirt sifter to remove small sticks and stones from the dirt used to cover your trap.

Common Land Sets

Four sets every land trapper should know are:

- 1) Dirt-hole set.
- 2) Flat set.
- 3) Cubby set.
- 4) Scent post.

Dirt-hole Set

The dirt-hole set is popular with fox and coyote trappers, and this type of set also attracts other furbearers. To make a dirt-hole set:

- Select a natural feature (clump of grass) for a backing at your set.
- Dig a small hole, about the diameter of a coffee cup, that slants back about 8" deep under the backing and put the dirt in your sifter.
- Dig a bed for your coil-spring trap in front of the hole so the trap center will be about 7 inches from the hole for fox or 12 inches for coyotes. (Bed can be dug 2 inches off center for fox and 4 inches off center for coyote to take advantage of the natural step pattern when approaching dirt-holes and other attractants.)
- Stake the trap down and bed as described previously.
- The bedded trap should be slightly below ground level.
- Put a cover on the pan and sift the dirt on top.
- Bait the set.

The hole by itself will attract a fox or coyote, but many trappers place bait in the hole. If you use bait, cover it with some light vegetation. A furbearer will smell it, but the grass will prevent birds of prey from seeing it and landing at your set.

You can apply lure to the back edge or inside the hole with the bait. Fox or coyote urine can also be put on the backing using a squirt bottle. Make certain you do not get any bait, lure, or urine on the trap bed.

Step-down Set

This set is a variation of the dirt hole set. Setting the trap in a shallow trench that extends in front of the dirt hole helps direct the animal's approach so it steps squarely on the trap pan.

Flat Set

A flat set is most effective for fox and coyote, but it too attracts other furbearers. The flat set is similar to a dirt-hole set, but no bait hole is dug. Instead, an attractor such as an old chunk of wood is used to get the furbearer's attention. To make a flat set:

- Place the attractor where a furbearer will see it.
- Dig a bed about 6 inches in front of the attractor.
- Stake the trap, bed it, and sift dirt over it.
- Put a few drops of lure or a squirt of urine on the attractor.

Scent Post Set

A scent post set (a variation of the flat set) is made the same as a flat set, except that a broom-handle sized stick is used instead of an attractor. The post should be about 8 inches tall. Use lure or urine on the side of the post nearest the trap.

Walk-through Set

This is a variation of a flat set and is useful when remaking the set after a capture has been made. Loose dirt and vegetation that is saturated with animal odors is used to guide the animal's approach.

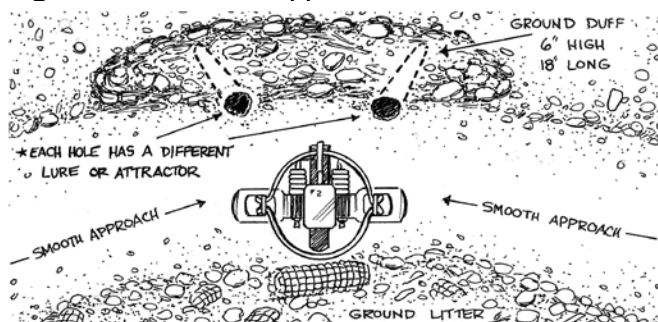

Step down set.

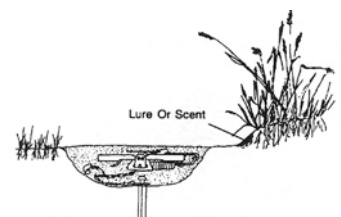

Flat set.

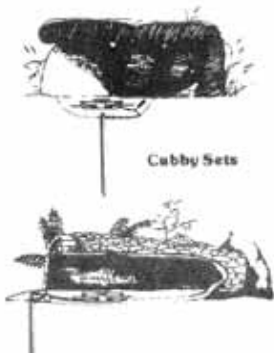

Enclosed trigger foot-hold traps are selective for raccoon and opossum. Due to this selectivity in Wisconsin they can be used in places where other traps cannot.

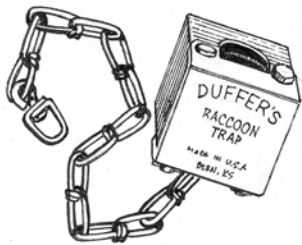

Joe Goodman

Duffer's™ Trap

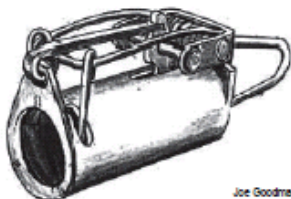

Joe Goodman

Lil' Griz™ trap.

Joe Goodman

Lil' Griz™ Trap

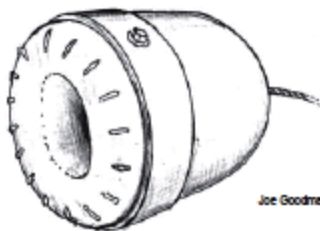

Joe Goodman

EGG™ trap.

Joe Goodman

EGG™ Trap

Cubby Set

The cubby set on land is made the same way as a cubby set for water trapping. Cubby sets are used for raccoon, fisher, opossum, bobcat, and other less wary furbearers. Cubby sets are generally not used for fox or coyote. To make a cubby set:

- Build a cubby and make certain the back is secure so the furbearer will enter from the front.
- Dig a bed for a coilspring trap at the opening.
- Bed the trap and cover it as previously described.
- Place appropriate lure or bait in the back of the cubby.

Enclosed Trigger Foot-hold Traps

Several types of enclosed trigger foot-hold traps are available for raccoon trappers. These traps are highly selective for raccoon because of their design and the feeding characteristics of raccoons. Enclosed trigger foot-hold traps are anchored and placed in the ground with baits attractive to raccoons, such as marshmallows, jam, and anise. The bait is placed in the bottom of the trap, below the trigger. Larger animals cannot get their paws through the smaller opening and smaller animals cannot reach the trigger. Additionally, the trigger is activated by pulling rather than pushing. When the raccoon attempts to remove the bait from the device, the trigger releases a small spring arm that keeps the foot within the device.

Procedures for setting and using enclosed foot-hold traps vary. Some require disassembly and special tools. Some need to be placed in the ground. Enclosed foot-hold traps made of metal may be dyed to help conceal them and reduce the chance of theft. Some trappers prefer to leave them shiny as a visual attractant for raccoons.

Body-grip Traps

The use of body-grip traps on land is highly regulated. However, even legal body-grip traps should be used with care to prevent the capture of pets or non-target wildlife.

Body-grip traps can be placed in boxes, buckets or other enclosures to prevent non-target animals from getting caught. ***Check the regulations for Wisconsin carefully.*** Various sized body-grip traps require special criteria for use on dry land. The size of the box enclosure, dimensions of the opening, distance the body-grip is set back, and placement of the enclosure on the landscape make this a selective method of trapping.

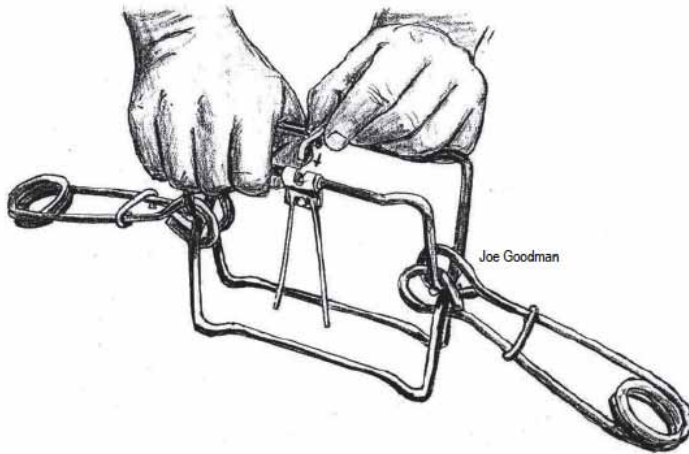

Below is a view of a body-grip box enclosure. Note the slots for the trap springs, and the wire hanging from the top. The back is covered with wood or wire mesh to keep the animal from reaching the bait without going to the trap.

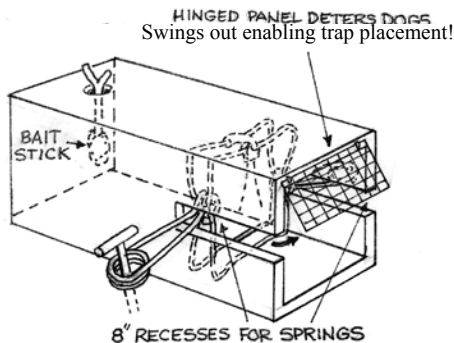

Avoid using this set in any location where dogs or cats could find the traps.

Trappers have developed several methods for setting body-grip traps in plastic buckets to prevent non-target catches. Cut slots in the sides for the trap springs. Suspend sweet baits inside the bucket.

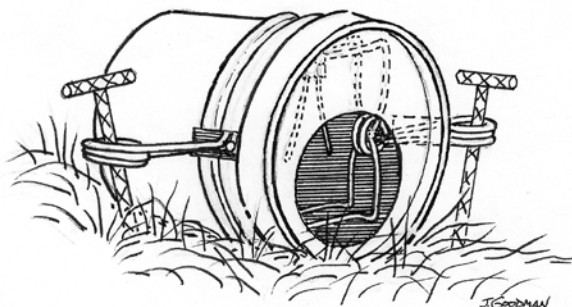

Round Pail Set

Practice safety when setting body-grip traps - use setting tongs, safety latches, and a safety gripper.

Use sweet baits for raccoon to avoid non-target animals:

- Marshmallows
- Anise
- Hard Candy
- Jam

Wooden boxes can be painted or allowed to weather so they blend in.

Some trappers camouflage their bucket while others prefer to leave them white as a visual attractant.

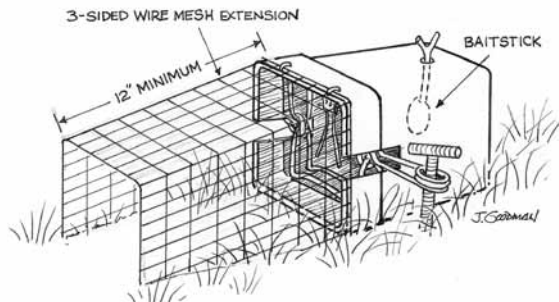
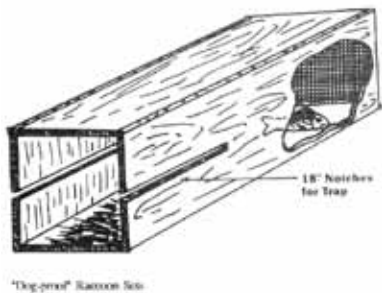

Bucket Set with Mesh Enclosure

Leaning pole sets can be used for fisher. A #160 body-grip trap baited with any fresh meat (muskrat/beaver) works well; salt can be used to prevent the meat from freezing. Use fisher musk, fisher urine, beaver castor or skunk essence for fisher lure. Making running pole sets under evergreen limbs to help keep snow from covering the traps. You can also use evergreen boughs to conceal bait from sight exposure.

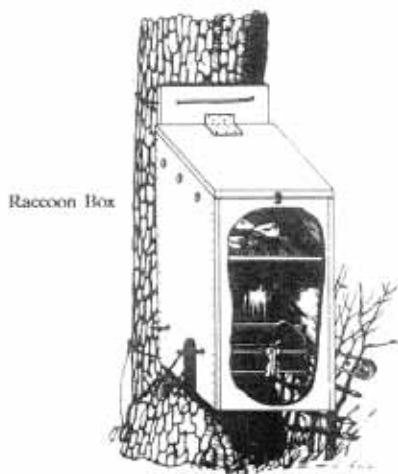

Wooden box for body-grip trap wired to a tree. The box can be placed low to the ground, face down to prevent dogs from getting in. Dig a depression under the trap for an added attractant.

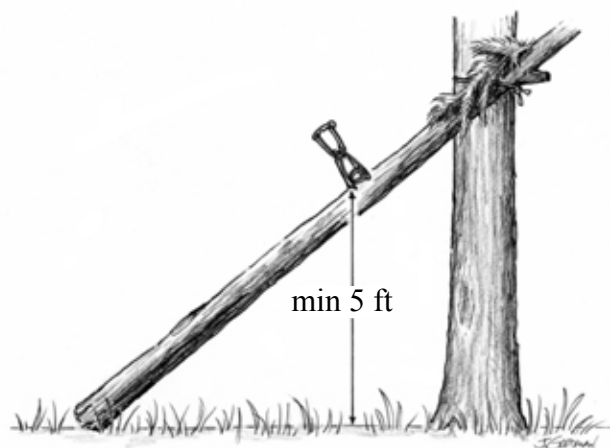

Chapter 12 Review – Land Sets

Objective - Students demonstrate an understanding of the procedures for making safe, effective, and selective sets on land.

Know that land trap locations influence animal welfare and the selectivity of trap sets.

1. Trappers should set their land traps at locations that:
 - a. Minimize exposure to _____ and _____ activities.
 - b. Prevent entanglement with _____ or other objects that might result in _____.
 - c. Are _____ to capture furbearers.
 - d. Avoid _____ used by _____.

2. Identify four good places to make land sets.
 - a. _____
 - b. _____
 - c. _____
 - d. _____

3. Name four types of common land sets
 - a. _____
 - b. _____
 - c. _____
 - d. _____

4. Name three furbearers commonly caught in dryland sets.
 - a. _____
 - b. _____
 - c. _____

Chapter 13

Cable Devices

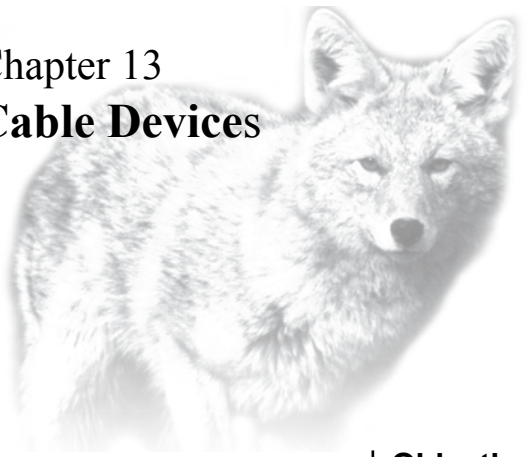

Objective - Students demonstrate an understanding of cable restraints, cable snares and responsible techniques for using them.

Introduction

Cable devices have a long history in Wisconsin. At one time, the use of cable devices were prohibited due to unregulated use and irresponsible behavior. In the mid-1980's, the WDNR again allowed regulated use of **cable snares** as water sets to reduce increasing beaver damage.

In 2001 and 2002, the WDNR, WTA, and WCC conducted a large scale, science based, field test of the **dryland cable restraints**. The results of the study showed cable restraints to be a highly selective, efficient and humane tool for restraining fox and coyote. As a result, cable restraints were allowed on dryland for coyote, fox, and bobcat.

The legislature directed the use of **cable devices** with the conditions that individuals use these systems with prescribed components and they be used responsibly. To do anything less will result in cable devices again being prohibited.

Cable Devices can be different things in Wisconsin!

Based on furbearer selectivity and intended restraint, Wisconsin trappers can use two cable devices. These cable devices, based on their intended use, will have different, key components. The **cable restraint** is a cable device used on land to live restrain fox, coyote and bobcat. The **cable snare** is a cable device used in water to act as a kill device for semi-aquatic furbearers, primarily beaver and otter.

It is very important that you read your current Trapping Regulations and follow all regulations for cable restraints and cable snares.

Components of Cable Devices

Cable restraints and cable snares are made of the same basic components: a cable, a lock, swivels, ferrules, and an attachment for anchoring. However, they also differ in several major ways. The following section will describe the

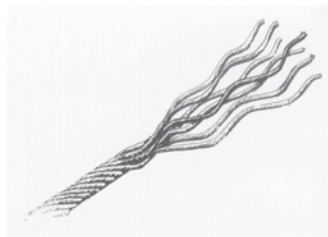

Natalene Cummings

Multi-strand steel cable - Used in modern cable devices.

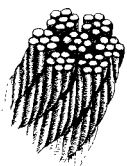

7x7 Cable



Natalene Cummings
7x19 Cable

shared components of each device. Specific details will be described in additional sections (cable restraints and cable snares).

Cable

Galvanized aircraft cable is the backbone of both cable restraints and cable snares. Cable sizes used vary from 3/32nd to 1/8th inch and are constructed of several smaller wires wrapped together.

The three types of cable are wrapped wires configured as 7x7; 7x19; or 1x19. The 7x7 consists of seven strands of small diameter wire wound into a larger strand. Then, seven of these larger strands are wound together to make the finished cable. This cable is of medium weight, very durable, has a coarse finish, and is the most commonly used cable. The 7x19 uses 19 small wires wound into a strand with seven of these strands making up the cable. This cable is light, supple, and has a smooth finish. Cable configured as 1x19 uses 19 strands wound tightly together to make the one. This cable is light, stiff, and has a smooth finish.

Lock

~ *Relaxing lock (Cable Restraint)*

A relaxing lock will move in either direction on the cable. When an animal pulls against the device it tightens, drawing the loop smaller. If an animal does not pull against the device, it relaxes. Animals can be released unharmed from cable restraints with relaxing locks. In Wisconsin, cable restraints can only use a reverse bend washer lock (with a minimum outside diameter of 1 1/4 inches).

~ *Nonrelaxing lock (Cable Snare)*

A non-relaxing lock keeps a cable from loosening after an animal is caught. This lock will allow the loop to become smaller with tension, but will not relax when tension stops. There are many types of non-relaxing locks available.

Swivels

Swivels are used in cable device anchoring systems to keep the animal from twisting and kinking the cable.

Ferrules

An end ferrule, also called a cable end or stop, is crimped on the end of a cable to keep the strands from unraveling. A specially crimped ferrule can also serve as a breakaway device for cable restraints.

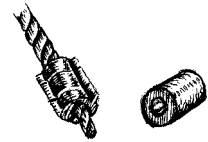

Natalene Cummings

Cable ferrule or stop.



Joe Goodman

Closed loop for anchoring incorporating a double ferrule.

Cable Restraints

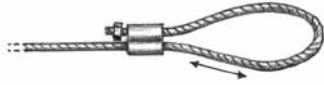

Joe Goodman

Slip noose for anchoring. Sometimes the double ferrule is crimped on one side to allow cable to slide through the other.



Ohio DOW Photos

End swivel for anchoring.



Breakaway Devices

- ~Breakaway Ferrule
- ~Breakaway S-Hook



Natalene Cummings

End swivel with box swivel.

The cable restraint is designed to capture and restrain unsuspecting animals during travel. The device is non-powered, and relies on forward movement of an animal to place and close the loop around its neck. In Wisconsin, cable restraints can only be used as a **Live-Restraining System** on dryland, requiring a relaxing lock and lock stop. The cable restraint system is versatile, and in other states with less domestic animals, can be designed to kill.

In Wisconsin, cable restraints incorporate a relaxing lock and are set in non-entanglement situations. They must be set in a manner that prevents the restraint from reaching a fence, rooted vegetation (over 1/2 inch in diameter), or other immovable objects. For most targeted animals, it is the probability of entanglement at the set, rather than the lock, that determines whether or not the device will kill. Consider all possibilities in a given area to be certain that entanglement is not possible.

Identify Cable Restraint Equipment and Materials

- A. Relaxing lock
- B. Side Profile of Nonmechanical lock
- C. Breakaway Device S-hook
- D. End Ferrule
- E. Stabilizer Tube
- F. Maximum Loop Stop
- G. Inline Swivel
- H. End Swivel
- I. Trap Tag
- J. Deer Stop
- K. Cable

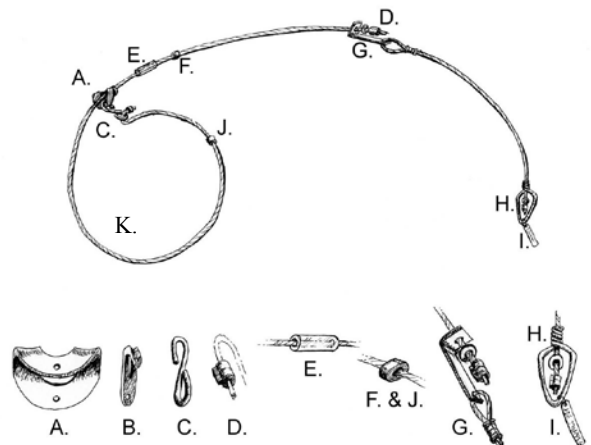

A. - B. Relaxing Lock – For a cable device to be a cable restraint it must have a relaxing lock. Only the reverse bend washer lock, with a minimum outside diameter of 1 ¼ inches, is legal in Wisconsin.

C. Breakaway Device – In Wisconsin, breakaway devices must be used to allow livestock, deer, wolves or other large mammals to escape. This breakaway is rated at 285 pounds or less. There are two acceptable breakaway devices: the breakaway “S” Hook and the ferrule. When sufficient force is applied, the “S” hook opens up on both ends or the ferrule breakaway slips off the end of the cable allowing the animal to leave with no part of the device on its body.

D. End Ferrule - Ferrule used to attach the loop system to the inline swivel.

E. Stabilizer Tube – A support collar, or whammy, is a small piece of coiled wire or plastic tubing slightly larger in diameter than the cable. The tube is slid on the cable during assembly. The support wire fits snugly into the support collar on the cable allowing the cable restraint to be set at a specific height in the targeted animal’s trail.

F. Maximum Loop Stop - The maximum loop stop prevents larger animals from entering the device, and the minimum loop stop prevents the device from closing too tight. Heavy gauge wire, steel nuts, or crimped ferrules are used to make the maximum loop stop.

G. Inline swivel - Prevents the cable restraint from binding as the animal moves in the capture circle. Inline swivels have a distinct advantage in areas with thick grasses and sedges.

H. End Swivel – The end swivel is used for anchoring the device. It also provides additional comfort to the animal and prevents the cable from kinking.

I. Trap Tag - A copper or brass tag with operator’s name and address or customer ID number is required in Wisconsin.

J. Deer stop - Trapping regulations require the use of a “stop” to prevent the cable loop from closing below a certain diameter. Some trappers call them deer stops or foot stops. Heavy gauge wire, steel nuts, or crimped ferrules are used to make deer stops.

K. Cable – Cable can be 7x7, 7x19, or 1x19. It must be 7 feet or less in length.

Constructing Cable Restraints

A variety of tools and knowledge are required to construct cable restraints. Quality parts and tools are purchased from reliable manufacturers or supply dealers. A working knowledge of cable behavior and device function is required.

For a cable restraint to perform efficiently and reliably, it must be constructed of good quality material and be assembled with care. Special attention is given to ensure each component matches the diameter of the cable and appropriate cable strength to capture the animal.

During construction, lay the cut lengths of cable on a flat surface and make sure they lay flat and are not sprung, kinked or damaged.

The parts are assembled in a logical sequence on the cable until the device

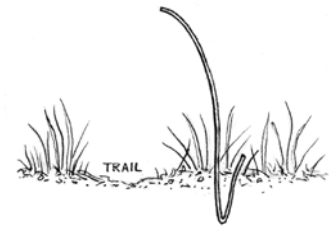

Joe Goodman

9 gauge loop support wire with unfrozen ground.

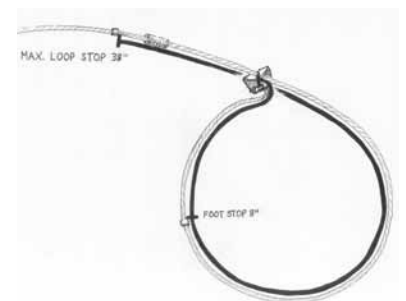

Natalene Cummings

Stops

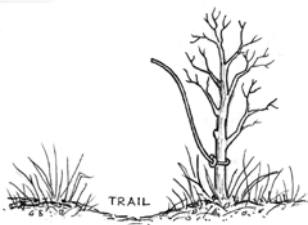

Joe Goodman

9 gauge support wire with frozen or unfrozen ground. If woody vegetation is greater than 1/2" diameter, it must be severed from the root system to prevent entanglement.

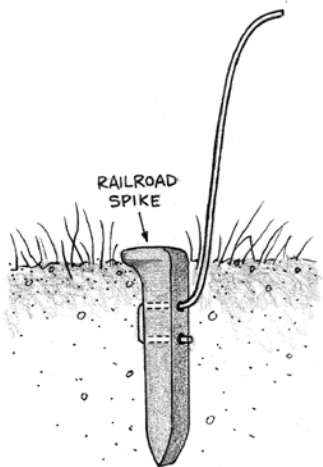

Joe Goodman

9 gauge loop support wire with frozen or unfrozen ground.



Natalene Cummings

Avoid setting cable devices in areas of high human or domestic animal activity.

is complete. An example would be to cut the cable to length, use a swagger to crimp an aluminum ferrule, add a washer and swivel, add the metal identification tag, crimp a stop, thread the lock on the cable, and attach a release ferrule or hook to the lock. In Wisconsin, the release must have a breakaway rating of 285 lbs. or less.

Check the operation of the device after assembly. The lock should move down the cable smoothly and relax when pulling stops. A completed cable restraint will lay flat on a horizontal surface.

Treating your Cable Restraints

Cable restraints can be treated before use on a trapline. Treating removes manufacturing lubricants from the metal parts as well as foreign odors from handling. Treatment steps:

- 1) Lay the cable restraints in a flat pan with high sides.
- 2) Mix a solution of water and concentrated soap.
- 3) Cover the cable restraints with the solution. Boil for ten minutes.
- 3) Remove from heat, pour off the liquid, and rinse with clean water.
- 4) Next, pour in a solution of one cup baking soda to two quarts of water.
- 5) Bring to a rapid boil, reduce temperature, and simmer for 20 minutes.
- 6) Pour off the liquid. Allow to air dry in an odor-free environment.
- 7) Store the restraints separately, each in their own sealed container.

Treating the cable restraints in this way turns them a dull gray color and helps to conceal them in the field. Natural scents can also be added by immersing them again in a solution containing bark, moss, plant leaves or spruce needles collected from your trapping area. This will also darken the cable restraints.

Setting Cable Restraints

Anchoring Systems

The end swivel can be attached to a single stake swivel, a double stake swivel, or an earth anchor. Be aware that any attachment, stake or loop needs to be strong enough to hold an animal that can pull with all four legs. A poorly anchored device will fail to hold the target species, and will not allow the breakaway system to function properly should a non-target species be captured.

Support wire

A support wire can be of 9 or 11 gauge wire. One end is inserted into the support collar to suspend the cable restraint in the animal's travelway. The other end is attached or welded to a piece of metal, such as a railroad tie stake, heavy nail, or rebar. The piece of metal is then pushed or hammered into the ground.

The support wire needs to be of sufficient length to suspend the device over the trail and accommodate for increasing snow depth throughout winter.

Responsibly Setting Cable Restraints

When setting cable restraints, stay away from trails used by people, livestock or domestic animals. Cable restraints work best in animal trails or as blind sets where the animal will encounter during travels. Narrow points and crossovers are common locations. Animal carcasses can also be used to draw animal activity. Animals frequently visit carcasses in their territory and trails lead to these locations. **Be advised that you must follow the sight-exposed bait law and that any sight exposed bait used with cable restraints must be greater than 25 feet away from the cable restraint!**

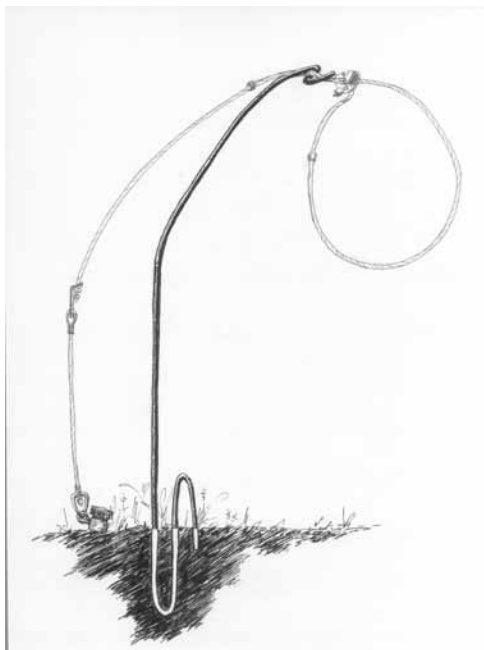

Natalene Cummings

Cable Device in Ground

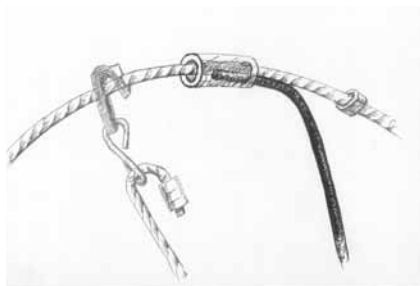

Stabilizer

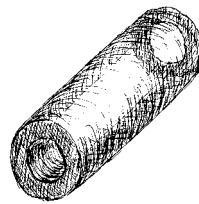

Tubing for Stabilizer



Natalene Cummings

Coyote.

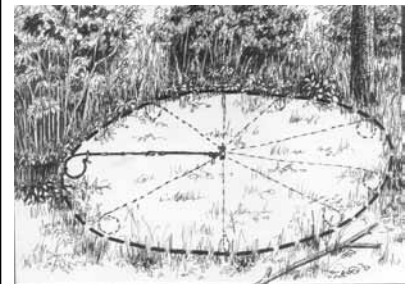

Natalene Cummings

Capture Circle.

Loop Sizes and Heights

Loop size and height are critical to the animal's welfare as well as the effectiveness and selectivity of the cable restraint. Small loops placed near the minimum height allowed are selective for neck catches on bobcat and fox. Larger loops placed near the maximum height allowed are selective for coyote.

The following list indicates general loop size and heights for various species. The loop size refers to the width and the height refers to the bottom of the loop

above the packed surface directly below the loop (dirt, packed snow, or ice).

- **Coyote cable loops** - Use a loop 10 - 12 inches in diameter and the bottom of the loop is 10 - 12 inches from the ground.
- **Bobcat cable loops** - Use a loop that is 8 inches in diameter and the bottom of the loop is 8 inches from the ground.
- **Fox cable loops** – Use a loop that is 6 - 8 inches in diameter and the bottom of the loop is 6 - 8 inches from the ground.

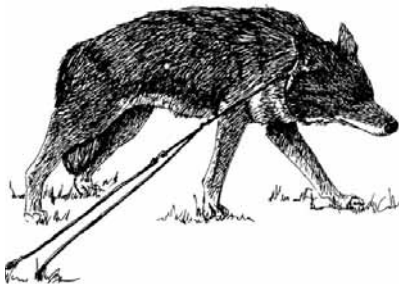
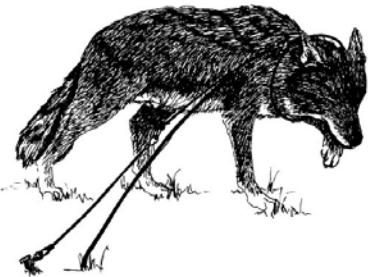
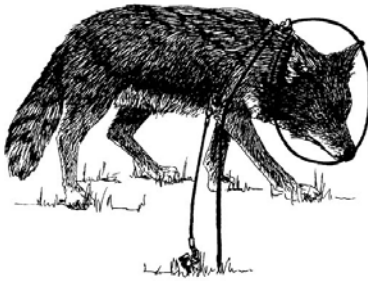

As an animal walks forward, the cable loop closes

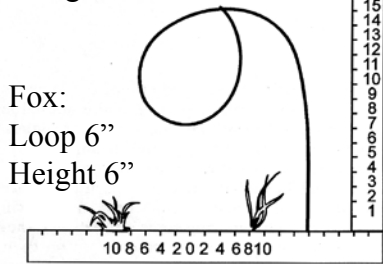
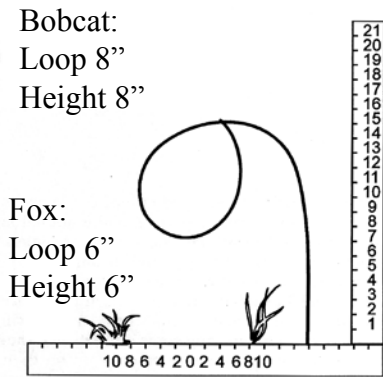
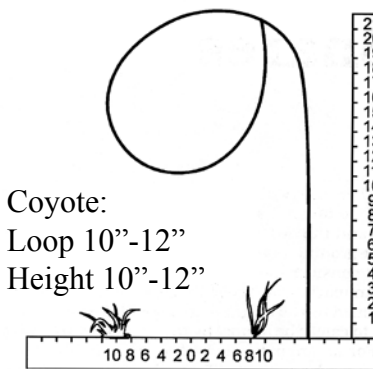

Reusable Components

A cable restraint becomes unusable once a capture is made. The captured animal exerts pressure on the cable and causes the cable to kink, bend, or curve against the natural wrap of the cable strands. The cable will no longer lay flat or be able to hang in a natural loop. The lock and swivel may be reused if they are not damaged. Inspect each carefully to insure they will work properly in the future. Simply cut the cable, remove the re-usable parts, and construct a device with new cable and ferrules.

Cable Snares

A **cable snare** is a non-powered cable device that uses forward movement of an animal to place and close the loop on its body. Cable snares use a non-relaxing lock that continually tightens, and is used as a killing system. The more force that is exerted the smaller the loop closes, resulting in a prompt death. In Wisconsin, cable snares can only be set in water and must be at least half submerged. Trappers commonly set cable snares to catch beaver around the body, as the head and neck are too short. They are commonly connected to submersion systems.

Identify Cable Snare Equipment and Materials

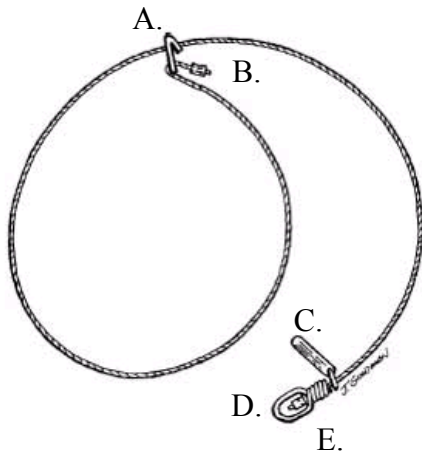

A. Non-relaxing lock

B. Ferrule/Stop

C. Trap Tag

D. End Swivel

E. End Ferrule/Stop

A. Non-relaxing Lock - Lock which continually tightens, and prevents the cable from relaxing.

B. Ferrule/Stop - Ferrules are crimped on the end of a cable to keep the strands from unraveling.

C. Trap Tag - A copper or brass tag with operator's name and address or customer ID number is required in Wisconsin.

D. End Swivel - The end swivel is used for anchoring the device. It also provides additional comfort to the animal and prevents the cable from kinking.

E. End Ferrule - An end ferrule, also called a cable end or stop, is crimped on the end of a cable to keep the strands from unraveling.

Set locations

Cable snares are placed in water where animal activity is either observed or by encouraging animal activity with lure or bait. As examples, beaver are enticed through a device at a lured castor mound or baited set, or in a blind set in a runway.

Beaver under water:
Loop 9"-10"
Height 1/3 above water,
2/3 below water

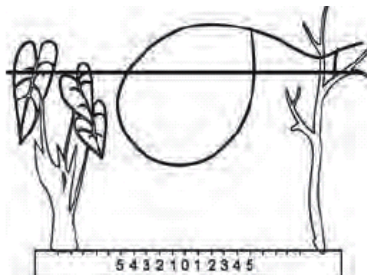

- **Beaver cable loop in water (for swimming beaver)** – Use a loop that is 9-10" in diameter with one third of the loop above the waterline.



Chris Tischaefter

Equipment belt used with cable restraints. Tools include pistol, lineman's pliers, fencing pliers and cable cutters.

A careful trapper can make sets under ice using cable snares. The cables can be attached to stout poles and stuck in the mud to make channel sets or baited sets for beaver. During the winter, trappers can chop a hole in the ice and push poles through the hole into the mud with cable snares baited for beaver. The under ice beaver set is one of the rare times when bait is recommended with a cable snare.

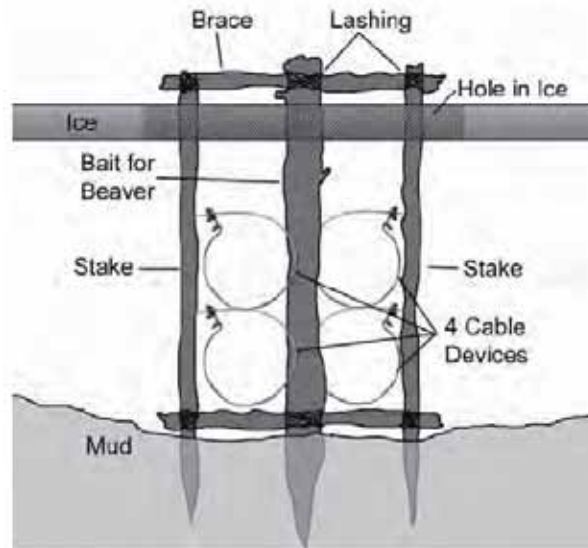

Key Points to Remember with all Cable Devices

- A cable restraint is NOT a cable snare.
- A cable snare is NOT a cable restraint.
- A cable restraint can ONLY be used on dryland and is a live-restraining device.
- A snare is used ONLY in the water and is a killing device.

Cable Devices and Incidental Catch

Wisconsin is blessed to host a variety of wildlife. As dedicated outdoorsmen and women, we must learn the landscape where we hunt and trap and know the types of animals we may encounter. The goal of setting cable devices is to catch the target species, and one of the primary considerations in doing so is to avoid incidental catches. Incidental catches of wolves, deer and livestock is addressed through the breakaway requirement. The incidental catch of domestic dogs is addressed through the relaxing lock and non-entanglement requirements. However, as responsible, ethical trappers, it is our responsibility to do everything within our power to reduce these occurrences.

We must be risk managers on our traplines. Knowing what animals may be present, knowing the appropriate capture system to employ, and evaluating the risk associated with each must be an ongoing and daily process. Incorrect loop size or loop height, poor location, illegal equipment, or failing to check your sets as required, will surely draw unneeded attention, and thereby increase the potential to lose these types of capture devices in Wisconsin.

Some incidental catches are sure to happen every season. Be prepared with the right equipment to release an unwanted catch. Make sure you have the contact information for the local Conservation Warden. You may need assistance.

Chapter 13 Review – Cable Devices

Objective - Students demonstrate an understanding of cable devices and responsible techniques for using them.

Identify cable device equipment and materials.

1. Match the labels below with their pictures.
 - a. Multi-strand steel cable
 - b. Cable restraint, relaxing lock, and deer stop
 - c. Swivel and ferrule
 - d. Support wire in collar.

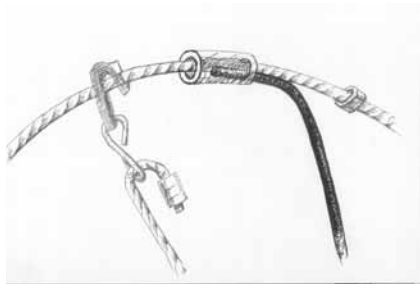
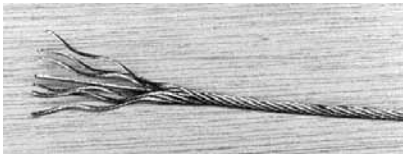

2. Use our state trapping regulations to determine which cable devices are legal to use in Wisconsin. If so, describe legal restrictions on the types of cable devices you can use.

- a. Cable Restraints: Legal on land? Yes No
- b. Cable Snares: Legal on land? Yes No
- c. Powered Cable Restraints: Legal on land? Yes No

4. Match the cable loop sizes and heights to the animal you want to catch.
- a. Loops 6-8 inches, bottom 6-8 inches off ground _____ Beaver
 - b. Loops 10-12 inches, bottom 10-12 inches off ground _____ Fox
 - c. Loops 9-10 inches, 1/3 above water, 2/3 below water _____ Bobcat
 - d. Loops 8 inches, bottom 8 inches off ground _____ Coyote
5. Wisconsin cable restraints can only be used as a _____ device.
6. _____ and _____ design are the two factors that determine whether the set will be lethal or just restrain.

Note: Due to the importance of understanding cable restraints as separate publication titled: Cable Restraints in Wisconsin, A Guide to Responsible Use, Publication # WM-443 is provided with this manual.